

# PERFILES SANITARIOS

## SANITARY PROFILES

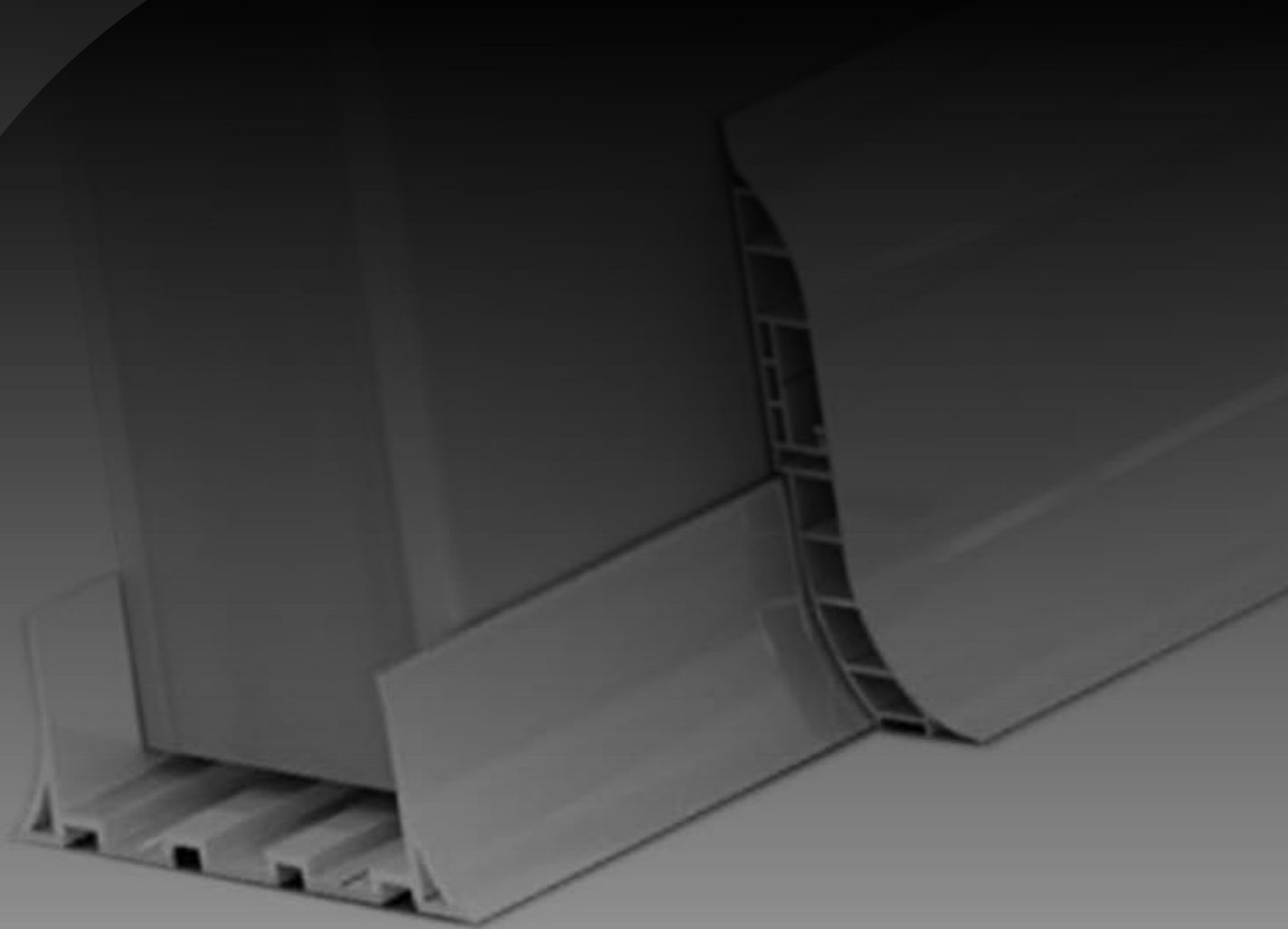

## 290 P

### Perfil sanitario con labios flexibles

Sanitary profiles with soft edges

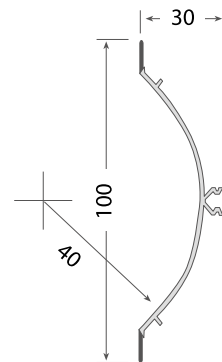

## 3300 A

### Perfil sanitario

Sanitary profiles

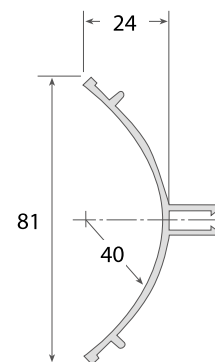

## 295

### Unión angular interior triple

Internal corner cap



Modelo Version	Código Code	Largo Length (mts)	Color Colour (Ral)	Material Material	Pedido mínimo Minimum order (mts)	Peso Weight (gr/mt)
<b>290 P</b>	F10 2805	4	9002	PVC	120	765
	F10 3318	4	9010	PVC	120	765
<b>3300 A</b>	F10 7271	4	9010	Aluminio Aluminium	1	2.200
<b>295</b>	F10 2815	-	9002	PVC	1	21 (gr/un)
	F10 3319	-	9010	PVC	1	21 (gr/un)

# 3305 A

## Unión angular interior triple

Internal corner cap

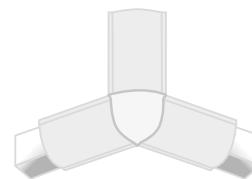
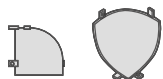

# 289

## Unión angular exterior

Large external corner cap

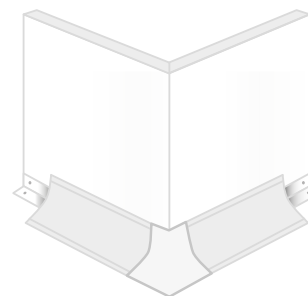

# COJ100

## Unión lineal

Lineal joint

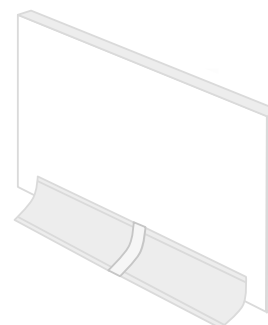
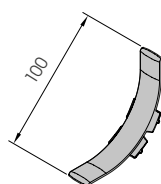

# 288

## Tapa final grande

Large end cap

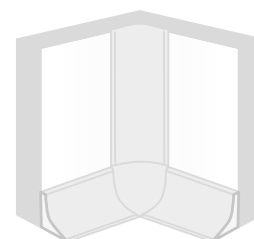

Modelo Version	Código Code	Largo Length (mts)	Color Colour (Ral)	Material Material	Pedido mínimo Minimum order	Peso Weight (gr/un)
<b>3305 A</b>	F10 7273	-	9010	Aluminio Aluminium	1	54
<b>289</b>	F10 3984	-	9002	PVC	1	16
	F10 3985	-	9010	PVC	1	16
<b>COJ100</b>	F10 5967	-	9002	PVC	1	9
	F10 5969	-	9010	PVC	1	9
<b>288</b>	F10 3986	-	9002	PVC	1	7
	F10 3987	-	9010	PVC	1	7

Ángulo de fijación para perfil 290-P / 3300 A

L-backing profile for 290-P / 3300 A

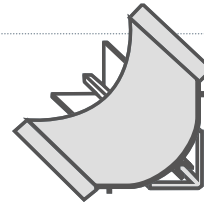

**316 P**

PVC

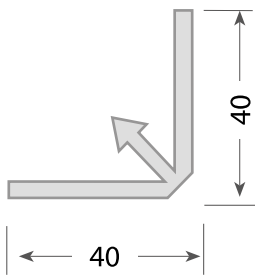

**291 A-3**

Aluminio  
Aluminium

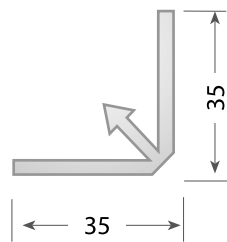

**315 P**

PVC

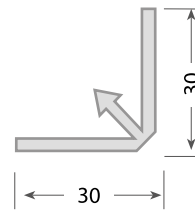

**299 A-25**

Aluminio  
Aluminium

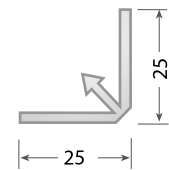

PVC



Aluminio  
Aluminium

Modelo Version	Código Code	Largo Length (mts)	Color Colour (Ral)	Material Material	Pedido mínimo Minimum order (mts)	Peso Weight (gr/mt)
<b>316 P</b>	F10 5559	4	9002	PVC	120	1.800
<b>291 A-3</b>	F10 2806	4	-	Aluminio Aluminium	120	317
<b>315 P</b>	F10 1364	4	9002	PVC	120	220
<b>299 A-25</b>	F10 8393	4	-	Aluminio Aluminium	120	195

## 3097 A+B

Perfil sanitario con labios flexibles

Sanitary profiles with soft edges

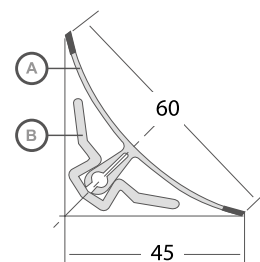

## 2738 A+B

Perfil sanitario con labios flexibles

Sanitary profiles with soft edges

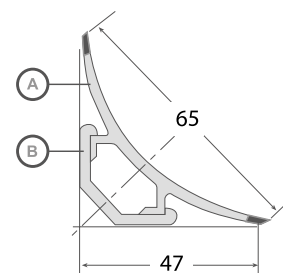

## 246 A+B

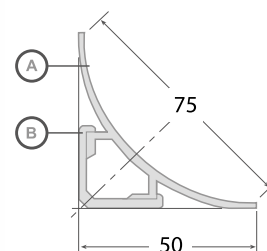
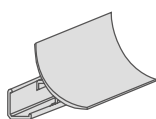

## 1020

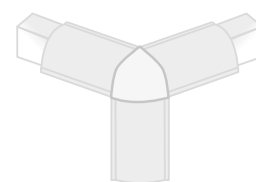

Modelo Version	Código Code	Largo Length (mts)	Color Colour (Ral)	Material Material	Pedido mínimo Minimum order (mts)	Peso Weight (gr/mt)
<b>3097 A+B</b>	F10 4472	4	9002	PVC	80	1.230
	F10 3811	4	9010	PVC	1000	1.230
<b>2738 A+B</b>	F10 4471	4	9002	PVC	100	1.130
	F10 3327	4	9010	PVC	100	1.130
<b>246 A+B</b>	F10 1935	4	9002	PVC	100	1.300
<b>1020</b>	F10 5715	Unidad	9002	PVC	-	110 (gr/un)

# 312

**Perfil sanitario**

Sanitary profiles

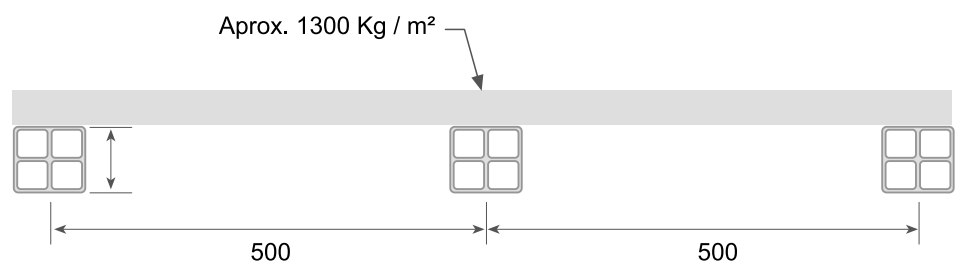
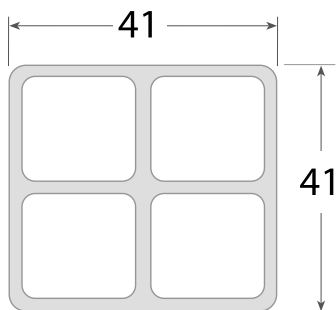
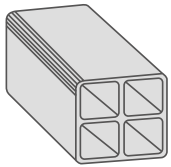

Modelo Version	Código Code	Largo Length (mts)	Color Colour (Ral)	Material Material	Pedido mínimo Minimum order (mts)	Peso Weight (kg)
312	F10 1149	4	Negro Black	PVC	40	1,6 (barra/bar)



# 293-V2

**Zócalo con labios flexibles y fijación oculta**

Plinth with soft edges on both sides and invisible fixing

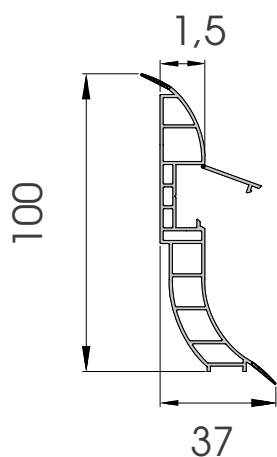

Modelo Version	Código Code	Largo Length (mts)	Color Colour (Ral)	Material Material	Pedido mínimo Minimum order (mts)	Peso Weight (kg/mt)
<b>293-V2</b>	F10 2810	4	9002	PVC	80	1,7
	F10 3328	4	9010	PVC	80	1,7



## PL2I / PL3I

Unión angular interior para zócalo  
Internal corner cap for plinth

PL2I

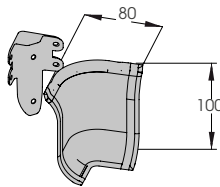

PL3I

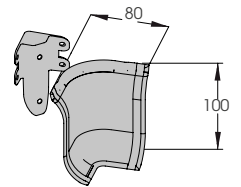

## PL2E

Unión angular exterior para zócalo  
External corner cap for plinth

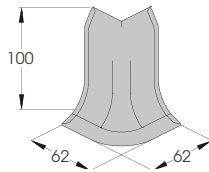

## PLTSX+DX

Conjunto tapas laterales para perfil zócalo  
End cap set for plinth profile

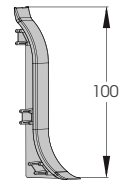
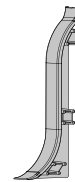

Modelo Version	Código Code	Unidad Unit	Color Colour (Ral)	Material Material	Caja Box (un.)	Peso Weight (gr/un)
PL2 I	FI0 5939	1	9002	PVC	50	29
	FI0 5942	1	9010	PVC	50	29
PL3 I	FI0 5940	1	9002	PVC	50	27
	FI0 5943	1	9010	PVC	50	27
PL2 E	FI0 5941	1	9002	PVC	50	42
	FI0 5944	1	9010	PVC	50	42
PLTSX+DX	FI0 5938	1	9002	PVC	100	15
	FI0 5945	1	9010	PVC	100	15

# TH-ALU-01

**Perfil T-omega en aluminio con fijación atérmica con rotura del puente térmico**

T-omega ceiling suspension profile made from aluminium with thermal break

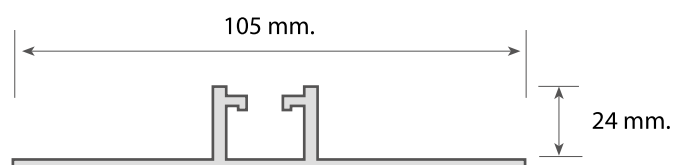

# A-326

**Conexión atérmica**

Connector

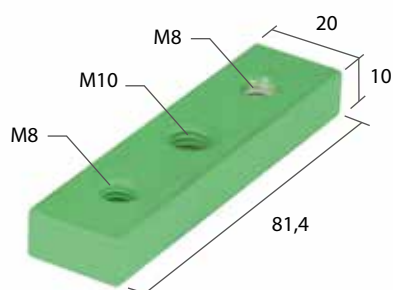
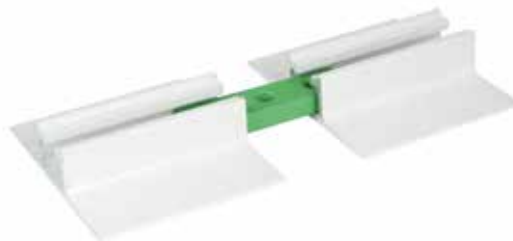

Modelo Version	Código Code	Largo Length	Color Colour (Ral)	Material Material	Caja Box (mts)	Peso Weight (gr)
TH-ALU-01	F10 3819	4 (mts)	9002	Aluminio Aluminium	8	5.4 (kg) (barra / bar)
A-326	F10 3835	un.	Verde Green	Aluminio pintado epoxi Epoxy painted aluminium	Unidad Unit	40 (gr/u)

# A88-M10 / 321 CH

Perfiles suspensión panel al techo y fijación.  
Pieza de fijación en acero zincado para perfil T en rosca M-10.

Ceiling suspension profiles and fixations.  
Zinc-plated fixing part with thread M-10 for hanging T profile.

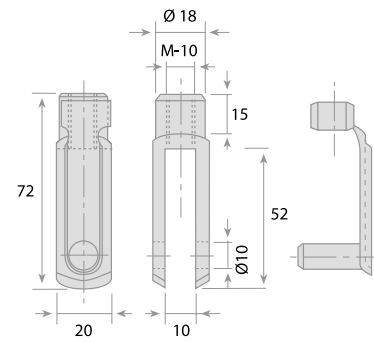

# 320 - TA

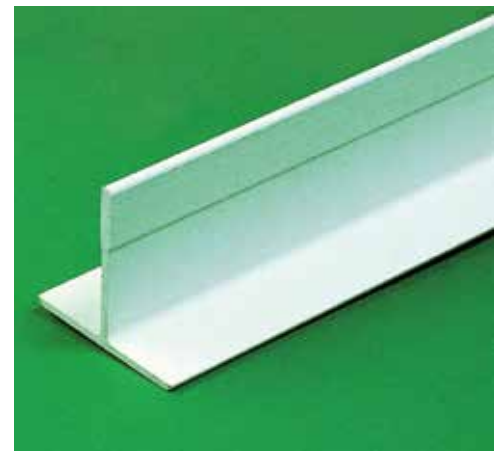
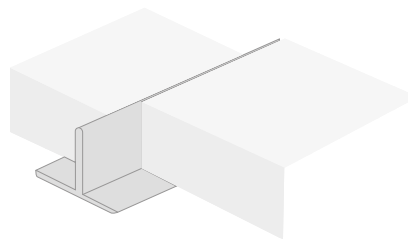
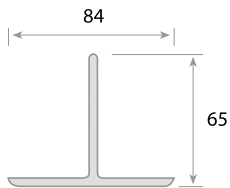

Modelo Version	Código Code	Largo Length (mts)	Color Colour (Ral)	Material Material	Caja Box (mts)	Peso Weight
<b>A88-M10</b>	F10 5711	Unidad Unit	Acero Steel	Acero zincado Zinc-plated	-	1.200 (gr/un)
<b>320 TA</b>	F10 5710	4	9010	Aluminio Aluminium	-	1.6 (kg/barra/ bar)

# 294

**Perfiles en U con bordes redondeados, fabricados en PVC rígido para fijación de paneles frigoríficos al suelo**

Rounded U channel profiles

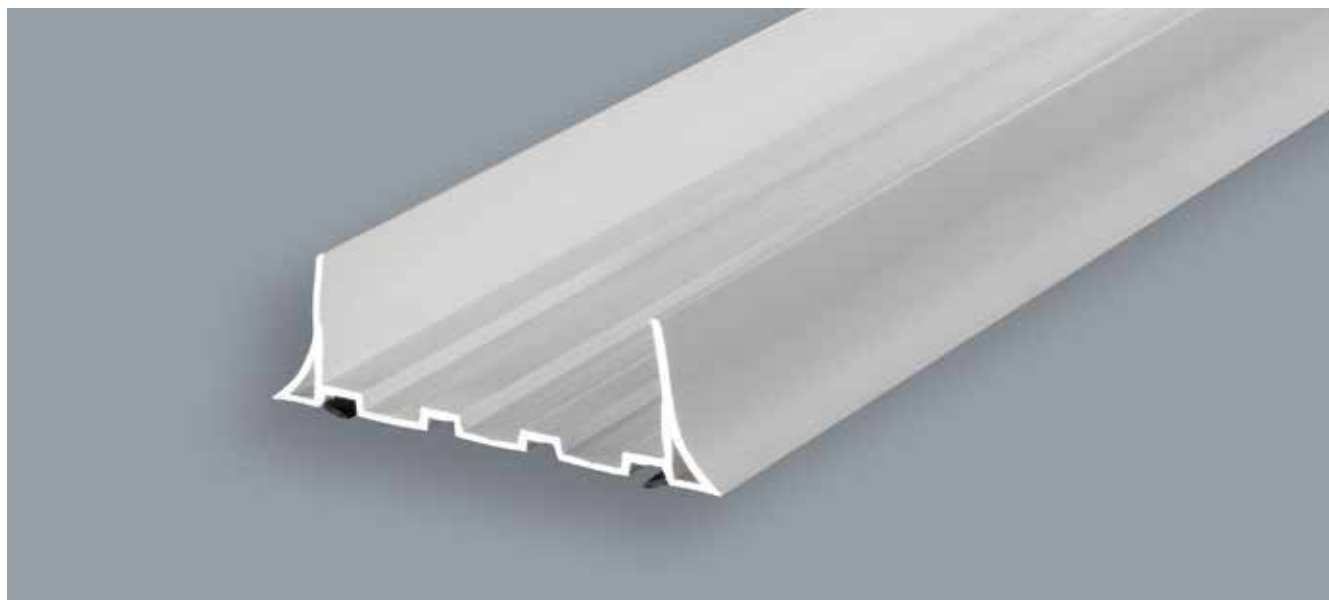

**294-6**

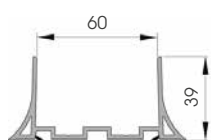

**294-10**

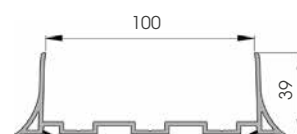

**294-8**

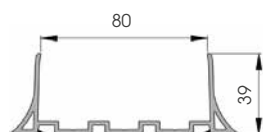

**294-12**

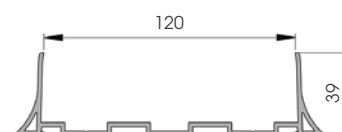

Modelo Version	Código Code	Largo Length (mts)	Color Colour (Ral)	Material Material	↔ (mm)	↕ (mm)	Peso Weight
<b>294-6</b>	F10 2811	3	9002	PVC	60	39	2.2 kg/p
<b>294-8</b>	F10 2812	3	9002	PVC	80	39	3 kg/p
<b>294-10</b>	F10 2813	3	9002	PVC	100	39	3 kg/p
<b>294-12</b>	F10 2814	3	9002	PVC	120	39	3.5 kg/p

## BL-312

Tornillo

Screws

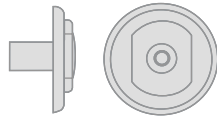

## BLP-316

Bulón pasante

Pitch screws

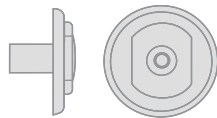

## BLI-350

Bulón con inserto metálico

Screw with metallic insert

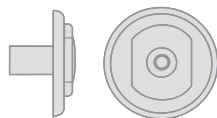

## A-314

Arandela

Washer

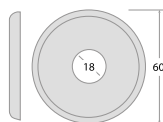

Modelo Version	Código Code	Unidad Unit	Color Colour (Ral)	Material Material	Métrico Metric	Caja Box (mts)	Peso Weight (gr/un)
BL-312-8	F10 2846	1	9002	POM	M-8	-	10
BL-312-10	F10 2876	1	9002	POM	M-10	-	11
BL-312-12	F10 1060	1	9002	POM	M-12	-	13
BLP-316-10	F10 5600	1	9002	POM	M-10	-	11
BLI-350-10	F10 9888	1	9002	POM	M-10	-	26
A-314	F10 2877	1	9002	POM	int. Ø18	-	6

## SCH-8 (M-12)

Bulón embellecedor en PVC con inserto metálico

PVC cover screw with metallic insert

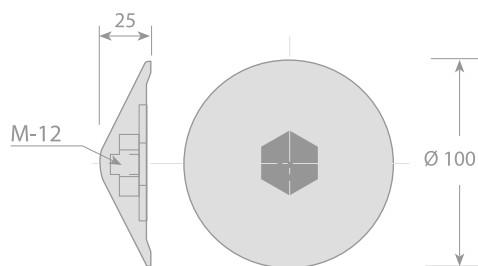

## SCH-9 (M-10)

Bulón embellecedor en PVC con inserto metálico

PVC cover screw with metallic insert

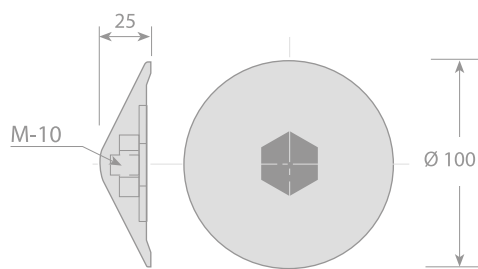

## SCH-1/2 (1/2")

Bulón embellecedor en PVC con inserto metálico

PVC cover screw with metallic insert

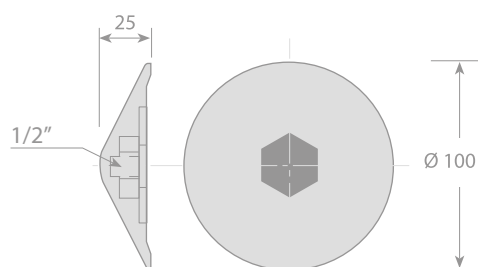

Modelo Version	Código Code	Unidad Unit	Color Colour (Ral)	Material Material	Caja Box (mts)	Peso Weight (gr/un)
SCH-8	F10 6003	1	9010	PVC	-	110
SCH-9	F10 3790	1	9010	PVC	-	85
SCH-1/2	F10 6002	1	9010	PVC	-	100

**Separadores de panel. Conjunto de 3 pies fabricado en P.A. negro.  
Soportan hojas de acero.**

Panel separator. 3 feet set panel separator made of P.A.  
Support the steel sheets.

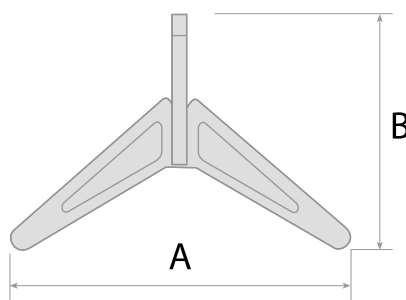
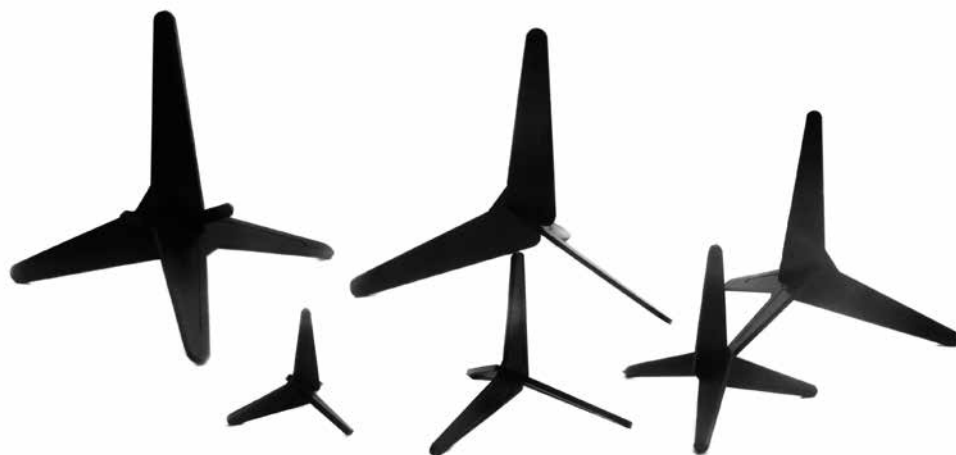

Modelo Version	Código Code	A ↔ (mm)	B ↓ (mm)	Caja Box (mts)	Peso Weight (gr/un)
<b>D-50</b>	FI0 7253	65	50	2500	4
<b>D-60</b>	FI0 7254	75	60	2000	5
<b>D-75</b>	FI0 7255	90	75	1000	6
<b>D-80</b>	FI0 7256	95	80	1000	7
<b>D-100</b>	FI0 7257	120	100	1000	9
<b>D-120</b>	FI0 7258	145	120	1000	18
<b>D-140</b>	FI0 7259	170	140	1000	25
<b>D-150</b>	FI0 7260	180	150	1000	26
<b>D-160</b>	FI0 7261	195	160	500	36
<b>D-180</b>	FI0 7262	220	180	500	42