

PERFILES SANITARIOS

SANITARY PROFILES

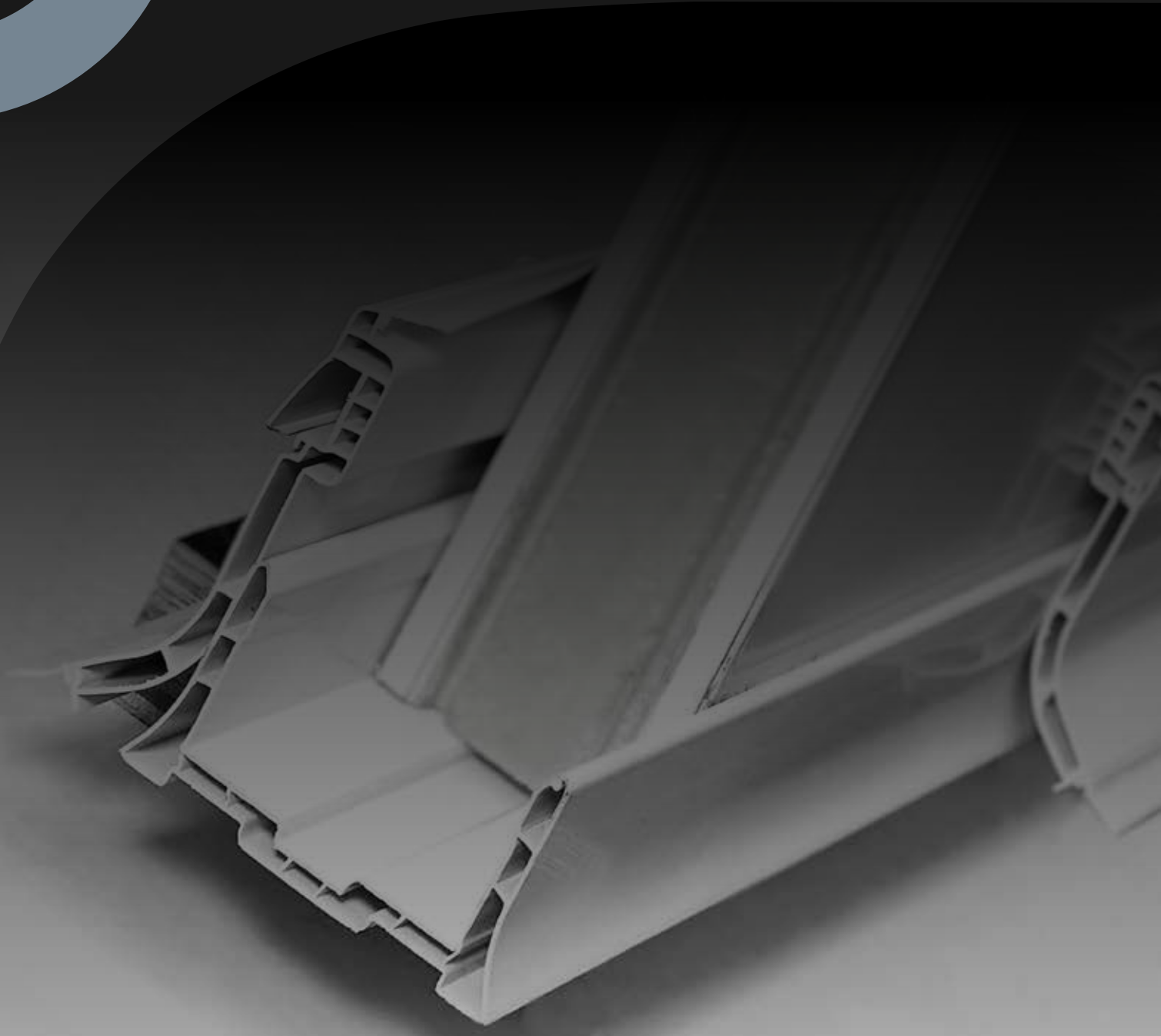

290 P

Perfil sanitario con labios flexibles

Sanitary profiles with soft edges

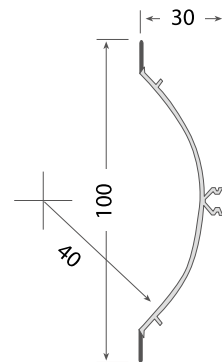

3300 A

Perfil sanitario

Sanitary profiles

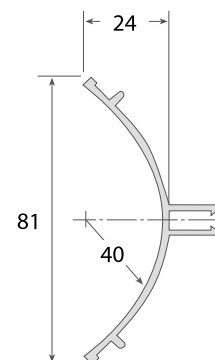

295

Unión angular interior triple

Internal corner cap



Modelo Version	Código Code	Largo Length (mts)	Color Colour (Ral)	Material Material	Pedido mínimo Minimum order (mts)	Peso Weight (gr/mt)
290 P	F10 2805	4	9002	PVC	120	765
	F10 3318	4	9010	PVC	120	765
3300 A	F10 7271	4	9010	Aluminio Aluminium	50	2.200
295	F10 2815	-	9002	PVC	1	21 (gr/un)
	F10 3319	-	9010	PVC	1	21 (gr/un)

3305 A

Unión angular interior triple

Internal corner cap

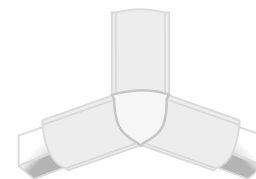
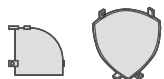

289

Unión angular exterior

Large external corner cap

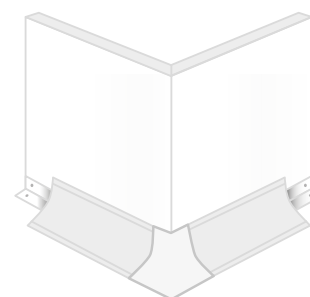

288

Tapa final grande

Large end cap

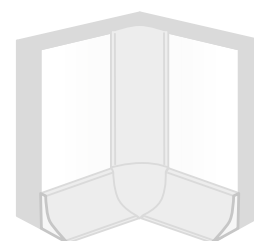

Modelo Version	Código Code	Largo Length (mts)	Color Colour (Ral)	Material Material	Pedido mínimo Minimum order	Peso Weight (gr/un)
3305 A	F10 7273	-	9010	Aluminio Aluminium	1	54
289	F10 3984	-	9002	PVC	1	16
	F10 3985	-	9010	PVC	1	16
288	F10 3986	-	9002	PVC	1	7
	F10 3987	-	9010	PVC	1	7

Ángulo de fijación para perfil 290-P / 3300 A

L-backing profile for 290-P / 3300 A

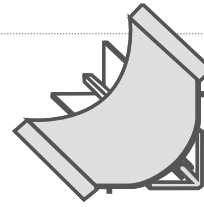

316 P

PVC

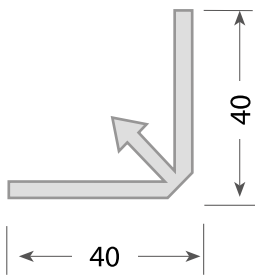

291 A-3

Aluminio
Aluminium

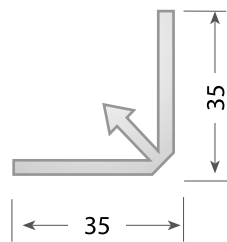

315 P

PVC

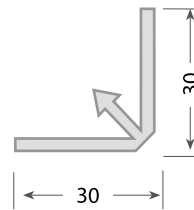

299 A-25

Aluminio
Aluminium

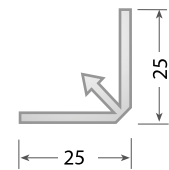

PVC



Aluminio
Aluminium

Modelo Version	Código Code	Largo Length (mts)	Color Colour (Ral)	Material Material	Pedido mínimo Minimum order (mts)	Peso Weight (gr/mt)
316 P	F10 5559	4	9002	PVC	120	1.800
291 A-3	F10 2806	4	-	Aluminio Aluminium	120	317
315 P	F10 1364	4	9002	PVC	120	220
299 A-25	F10 8393	4	-	Aluminio Aluminium	120	195

3097 A+B

Perfil sanitario con labios flexibles

Sanitary profiles with soft edges

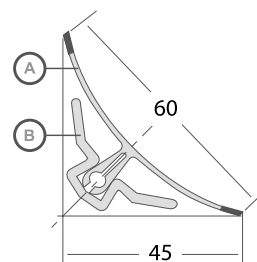

2738 A+B

Perfil sanitario con labios flexibles

Sanitary profiles with soft edges

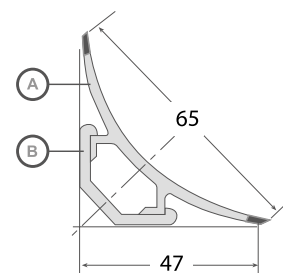

246 A+B

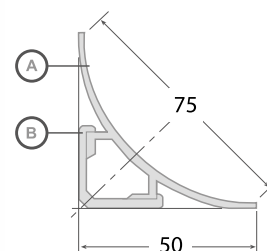
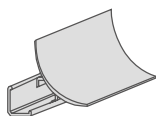

1020

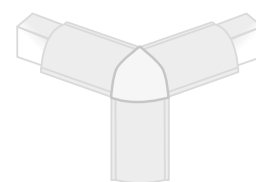

Modelo Version	Código Code	Largo Length (mts)	Color Colour (Ral)	Material Material	Pedido mínimo Minimum order (mts)	Peso Weight (gr/mt)
3097 A+B	F10 4472	4	9002	PVC	80	1.230
	F10 3811	4	9010	PVC	80	1.230
2738 A+B	F10 4471	4	9002	PVC	100	1.130
	F10 3327	4	9010	PVC	100	1.130
246 A+B	F10 1935	4	-	PVC	100	1.300
1020	F10 5715	Unidad	-	PVC	-	110 (gr/un)

312

Perfil sanitario

Sanitary profiles

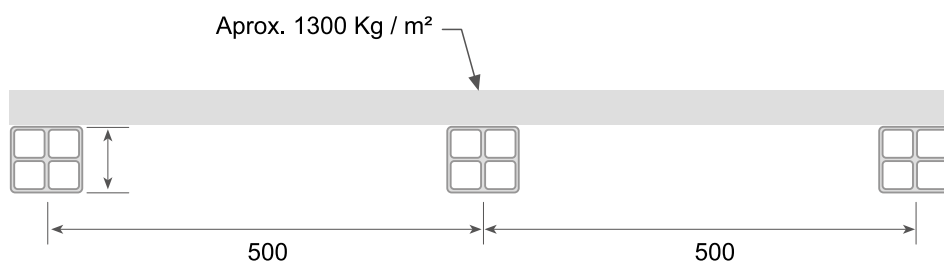
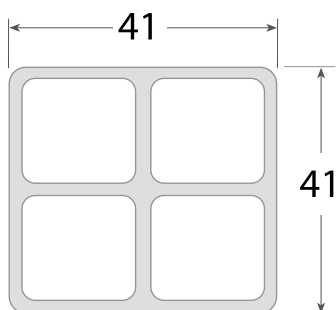
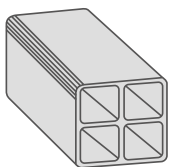

Modelo Version	Código Code	Largo Length (mts)	Color Colour (Ral)	Material Material	Pedido mínimo Minimum order (mts)	Peso Weight (kg)
312	F10 1149	4	Blanco Negro Gris White Black Grey	PVC	30	2,1



293

Zócalo con labios flexibles y fijación oculta

Plinth with soft edges on both sides and invisible fixing

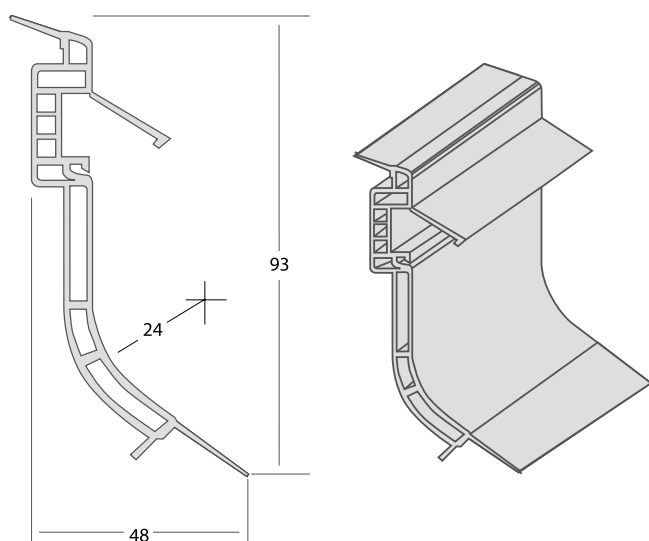

Modelo Version	Código Code	Largo Length (mts)	Color Colour (Ral)	Material Material	Pedido mínimo Minimum order (mts)	Peso Weight (kg)
293	F10 2810	4	9002	PVC	80	1,7
	F10 3328	4	9010	PVC	80	1,7



TH-ALU-01

Perfil T-omega en aluminio con fijación atérmica con rotura del puente térmico

T-omega ceiling suspension profile made from aluminium with thermal break

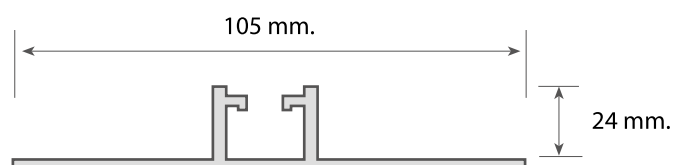

A-326

Conexión atérmica

Connector

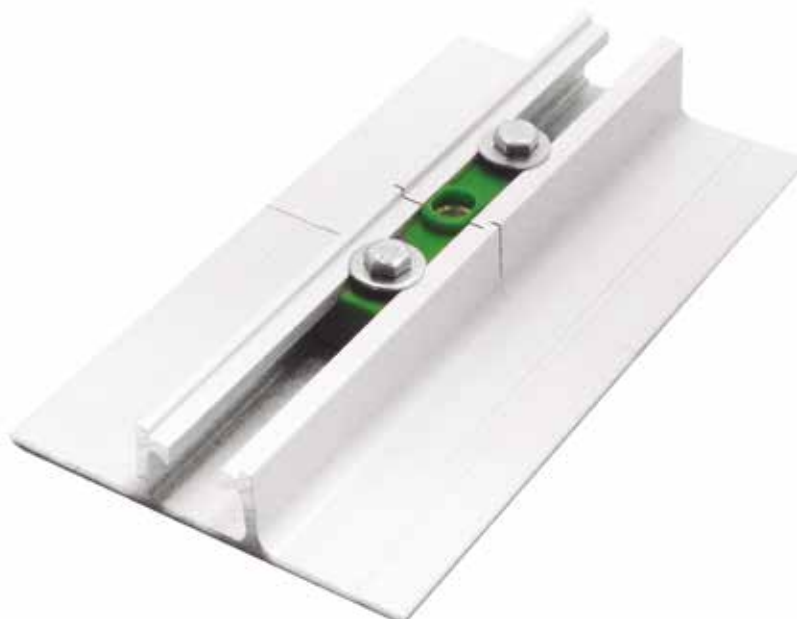

Modelo Version	Código Code	Largo Length (mts)	Color Colour (Ral)	Material Material	Caja Box (mts)	Peso Weight (gr)
TH-ALU-01	F10 3819	4	9002	Aluminio Aluminium	8	5.460
A-326	F10 3835	10	Verde Green	Aluminio sobreinyectado Overinjected aluminium	Unidad Unit	60

A88-M10 / 321 CH

Perfiles suspensión panel al techo y fijación.
Pieza de fijación en acero zincado para perfil T en rosca M-10.

Ceiling suspension profiles and fixations.
Zinc-plated fixing part with thread M-10 for hanging T profile.

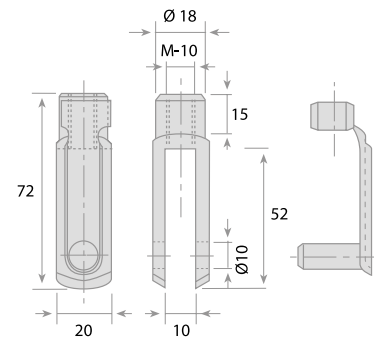

320 - TA

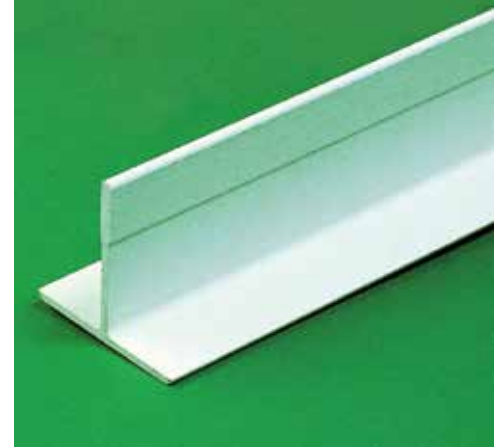
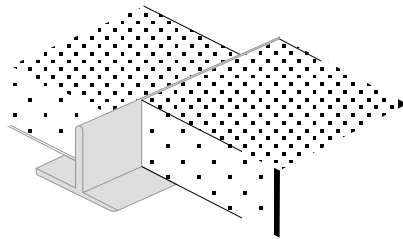
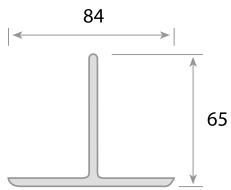

Modelo Version	Código Code	Largo Length (mts)	Color Colour (Ral)	Material Material	Caja Box (mts)	Peso Weight (gr/mt)
A88-M10	F10 5711	Unidad Unit	Acero Steel	Acero zincado Zinc-plated	-	1.200 (gr/un)
320 TA	F10 5710	4	9010	Aluminio Aluminium	-	1.625

294

Perfiles en U con bordes redondeados, fabricados en PVC rígido para fijación de paneles frigoríficos al suelo

Rounded U channel profiles

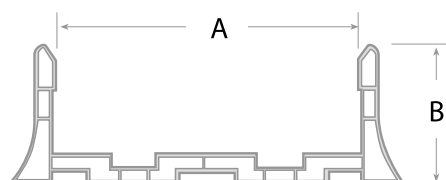

298

Tapa lateral para perfil en U

Upper piece accessory

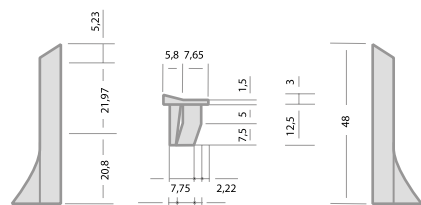

Modelo Version	Código Code	Largo Length (mts)	Color Colour (Ral)	Material Material	A ↔ (mm)	B ↓ (mm)	Peso Weight (gr/mt)
294-6	F10 2811	3	9002	PVC	60	45	500
294-8	F10 2812	3	9002	PVC	80	45	600
294-10	F10 2813	3	9002	PVC	100	45	600
294-12	F10 2814	3	9002	PVC	120	45	700
					Unidad Unit		
298	F10 2818	-	9002	PVC	1		2 (gr/un)

BL-312

Tornillo

Screws

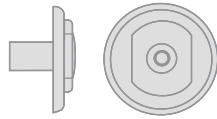

BLP-316

Bulón pasante

Pitch screws

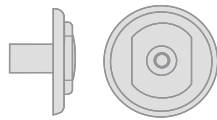

BLI-350

Bulón con inserto metálico

Screw with metallic insert

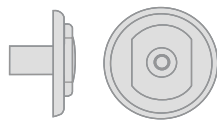

A-314

Arandela

Washer

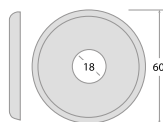

Modelo Version	Código Code	Unidad Unit	Color Colour (Ral)	Material Material	Métrico Metric	Caja Box (mts)	Peso Weight (gr/un)
BL-312-8	F10 2846	1	9002	POM	M-8	-	10
BL-312-10	F10 2876	1	9002	POM	M-10	-	11
BL-312-12	F10 1060	1	9002	POM	M-12	-	13
BLP-316-10	F10 5600	1	9002	POM	M-10	-	11
BLI-350-10	F10 9888	1	9002	POM	M-10	-	26
A-314	F10 2877	1	-	-	-	-	6

SCH-8 (M-12)

Bulón embellecedor en PVC con inserto metálico

PVC cover screw with metallic insert

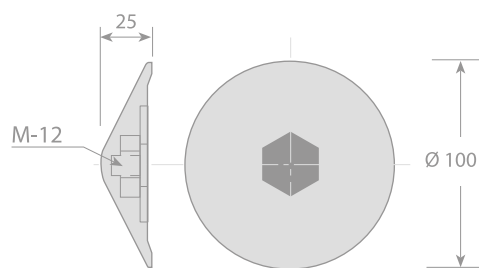

SCH-9 (M-10)

Bulón embellecedor en PVC con inserto metálico

PVC cover screw with metallic insert

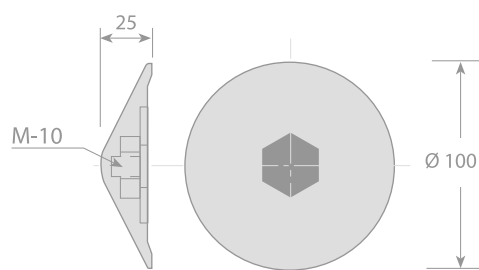

Modelo Version	Código Code	Unidad Unit	Color Colour (Ral)	Material Material	Caja Box (mts)	Peso Weight (gr/un)
SCH-8	F10 6003	1	9010	PVC	-	110
SCH-9	F10 3790	1	9010	PVC	-	85

**Separadores de panel. Conjunto de 3 pies fabricado en P.A. negro.
Soportan hojas de acero.**

Panel separator. 3 feet set panel separator made of P.A.
Support the steel sheets.

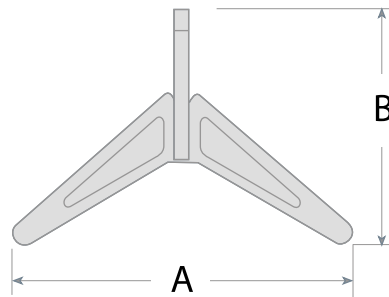

Modelo Version	Código Code	A ↔ (mm)	B ↓ (mm)	Caja Box (mts)	Peso Weight (gr)
D-50	FI0 7253	65	50	2500	4
D-60	FI0 7254	75	60	2000	5
D-75	FI0 7255	90	75	1000	6
D-80	FI0 7256	95	80	1000	7
D-100	FI0 7257	120	100	1000	9
D-120	FI0 7258	145	120	1000	18
D-140	FI0 7259	170	140	1000	25
D-150	FI0 7260	180	150	1000	26
D-160	FI0 7261	195	160	500	36
D-180	FI0 7262	220	180	500	42