

# IA / IL

**Guías fabricadas en acero zincado y cojinetes en acetal**

- Colocación angular
- Capacidad de carga: 30 Kgs. (Extendida)

**Slides made of zinc-coated steel with acetal roller bearings**

- Corner position
- Loading capacity: 30 Kgs. (Opened)

IA



IL



L 350 mm

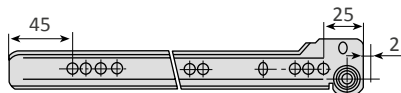

L 400 mm



L 450 mm

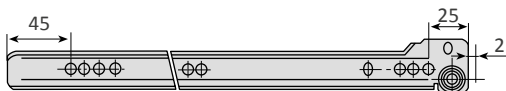

L 500 mm



L 550 mm



L 600 mm



## IA SIMPLE / IL SIMPLE

Modelo Version	Código Code	Peso Weight (gr.)
IA-35	F10 1924	384
IA-40	F10 1050	429
IA-45	F10 1051	531
IA-50	F10 1052	588
IA-55	F10 1925	645
IA-60	F10 1926	703
IL-35	F10 1921	344
IL-40	F10 1053	362
IL-45	F10 1054	446
IL-50	F10 1055	537
IL-55	F10 1922	580
IL-60	F10 0656	600

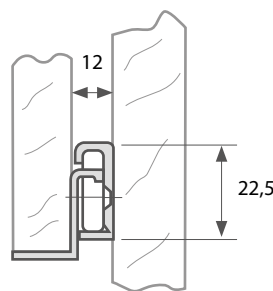

IA

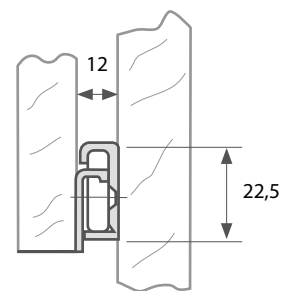

IL

# CPV



**Guías fabricadas en acero inoxidable o zincado con rodamientos en acetal**

- Capacidad de carga: 50 Kgs. (Extendida)

**Slides made in stainless steel or zinc-coated steel**

- Loading capacity: 50 Kgs. (Opened)

## CPV SIMPLE

Modelo Version	Código Code	Largo Length (mm.)	Extensión Extension (mm.)	Peso Weight (kg.)
<b>Inoxidable / Stainless steel</b>				
<b>CPV-40 I</b>	F10 3880	400	584	1
<b>CPV-45 I</b>	F10 3881	450	656	1,19
<b>CPV-50-I</b>	F10 3882	500	730	1,32
<b>CPV-55-I</b>	F10 3883	550	803	1,47
<b>Acero zincado / Zinc coated steel</b>				
<b>CPV-40 H</b>	F10 3884	400	572	1,20
<b>CPV-45 H</b>	F10 3885	450	644	1,34
<b>CPV-50-H</b>	F10 3886	500	719	1,50
<b>CPV-55-H</b>	F10 3887	550	793	1,65

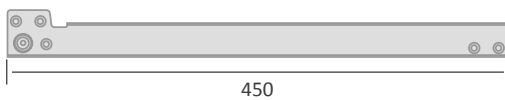
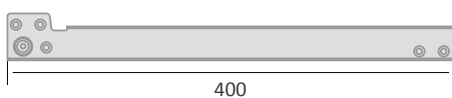

# CP



### Guías telescópicas en acero inoxidable AISI 304

- Los rodillos de acetal y los topes de P.A.
- Capacidad de carga: 60 Kgs. (Extendida)

### Stainless steel AISI 304

- Full extension slides, acetal rollers and P.A. and parts
- Loading capacity: 60 Kgs. ( Opened )

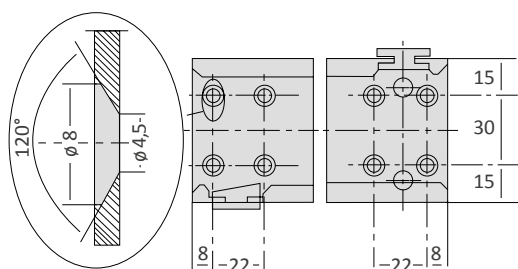
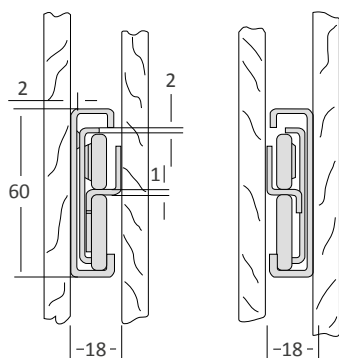
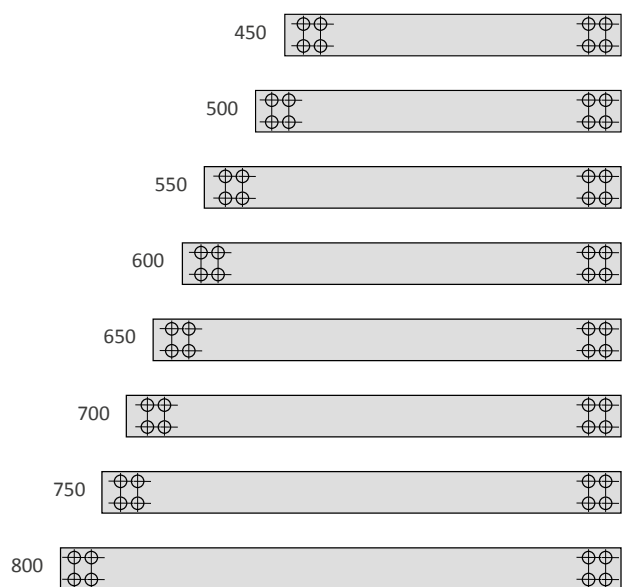

## CP

Modelo Version	Código Code	Largo Length (mm.)	Extensión Extension (mm.)	Peso Weight (kg.)
<b>CP-40</b>	F10 2700	400	460	2
<b>CP-45</b>	F10 3900	450	510	2,5
<b>CP-50</b>	F10 3901	500	560	2,8
<b>CP-55</b>	F10 3902	550	610	3,1
<b>CP-60</b>	F10 3903	600	660	3,3
<b>CP-65</b>	F10 3904	650	710	3,6
<b>CP-70</b>	F10 3905	700	760	3,9
<b>CP-75</b>	F10 3906	750	810	4,2
<b>CP-80</b>	F10 3907	800	860	4,4



# MR

**Guías telescópicas en acero inoxidable AISI 304 y en Acero galvanizado**

- Capacidad de carga: 50 Kgs. (Extendida)

**Stainless steel AISI 304 and galvanized steel full extension slides**

- Loading capacity: 50 Kgs. (Opened)

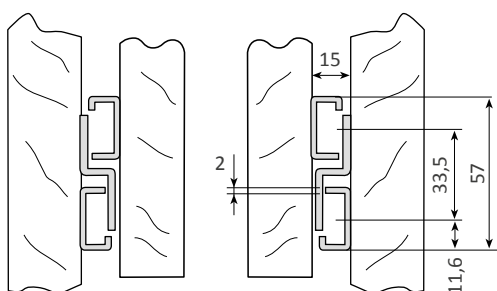
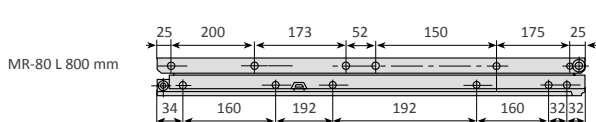
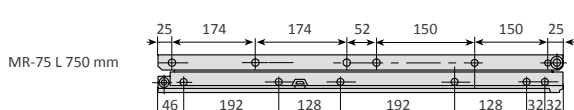
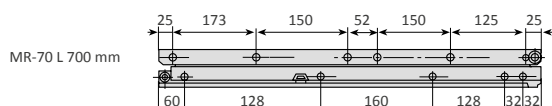
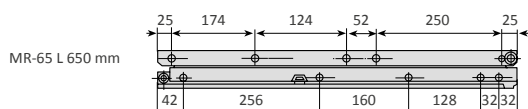
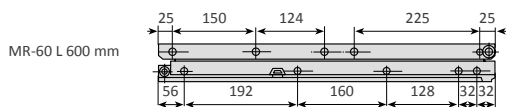
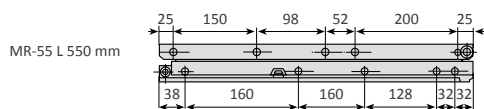
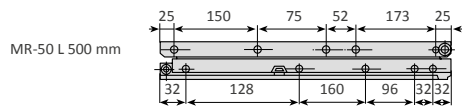
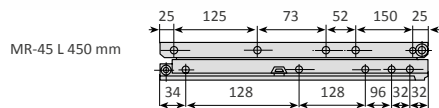

## MR

Modelo Version	Código Code	Largo Length (mm.)	Extensión Extension (mm.)	Peso Weight (kg.)
<b>Inoxidable / Stainless steel</b>				
<b>MR-45</b>	FI0 0426	450	450	2,1
<b>MR-50</b>	FI0 1870	500	500	2,2
<b>MR-55</b>	FI0 1871	550	550	2,4
<b>MR-60</b>	FI0 1872	600	600	2,7
<b>MR-65</b>	FI0 1873	650	650	2,9
<b>MR-70</b>	FI0 1874	700	700	3,1
<b>MR-75</b>	FI0 1875	750	750	3,4
<b>MR-80</b>	FI0 0427	800	800	3,5
<b>Acero galvanizado / Galvanized steel</b>				
<b>MRH-45</b>	FI0 9156	450	450	2,1
<b>MRH-50</b>	FI0 9157	500	500	2,2
<b>MRH-55</b>	FI0 9158	550	550	2,4
<b>MRH-60</b>	FI0 9159	600	600	2,7

## CONJUNTO / KIT

### Conjunto corredera para puertas neutras

#### Sliding kits for neutral doors

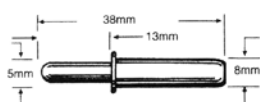
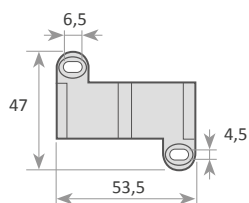
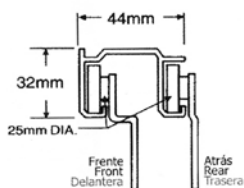

Modelo Version	Código Code	Longitud Length (mm.)	Peso Weight (gr.)
-------------------	----------------	-----------------------------	-------------------------

### CA-2041 - 3041

Rail para puertas correderas en aluminio anodizado  
Rail for sliding doors in anodized aluminium

CA 2041	FI0 5056	2.000	944
CA 3041	FI0 5057	3.000	1400

### CA-1141

Guía para puertas corredera de 19 mm  
Slide for slyding doors of 19 mm.

CA-1141	FI0 5062	-	30
---------	----------	---	----

### CA-5041

Tope de sujeción en latón cromado con muelle de retorno para puertas corredera  
Fixing ends in chromed brass with return sprng for sliding doors

CA-5041	FI0 5060	38	5
---------	----------	----	---

### CA-6041

Tope fin de carrera en acero inoxidable con paragolpes en caucho  
Keep mine cage in stainless steel with rubber

CA-6041	FI0 5061	-	15
---------	----------	---	----

# CONJUNTO / KIT

## Conjunto corredera para puertas inox

- Soporte en acero Inoxidable con rodamiento para puertas correderas delanteras y traseras

## Sliding kits for stainless steel doors

- Support in stainless steel with bearing for front and back sliding doors.

Modelo Version	Código Code	Descripción Description	Peso Weight (gr.)	Modelo Version	Código Code	Descripción Description	Peso Weight (gr.)
<b>CA 7041</b> Delantero - Nylon / Front - Nylon				<b>CA 4041</b> Trasero - Nylon / Back - Nylon			
	<b>CA 7041</b>	F10 2256 · Plana · Nylon · Cojinete sin bolas  · Flat · Nylon · Non- balls bearing	42		<b>CA 4041</b>	F10 2257 · Plana · Nylon · Cojinete sin bolas  · Flat · Nylon · Non- balls bearing	40
<b>CA 8041</b> Delantero - Nylon / Front - Nylon				<b>CA 0141</b> Trasero - Nylon / Back - Nylon			
	<b>CA 8041</b>	F10 5058 · Plana · Nylon · Cojinete de bolas  · Flat · Nylon · Balls bearing	52		<b>CA 0141</b>	F10 5059 · Plana · Nylon · Cojinete de bolas  · Flat · Nylon · Balls bearing	50
<b>CA 6141</b> Delantero - Inox / Front - Inox				<b>CA 9041</b> Trasero - Inox / Back - Inox			
	<b>CA 6141</b>	F10 2259 · Plana · Metálica · Cojinete de bolas  · Flat · Metallic · Balls bearing	56		<b>CA 9041</b>	F10 2260 · Plana · Metálica · Cojinete de bolas  · Flat · Metallic · Balls bearing	54