

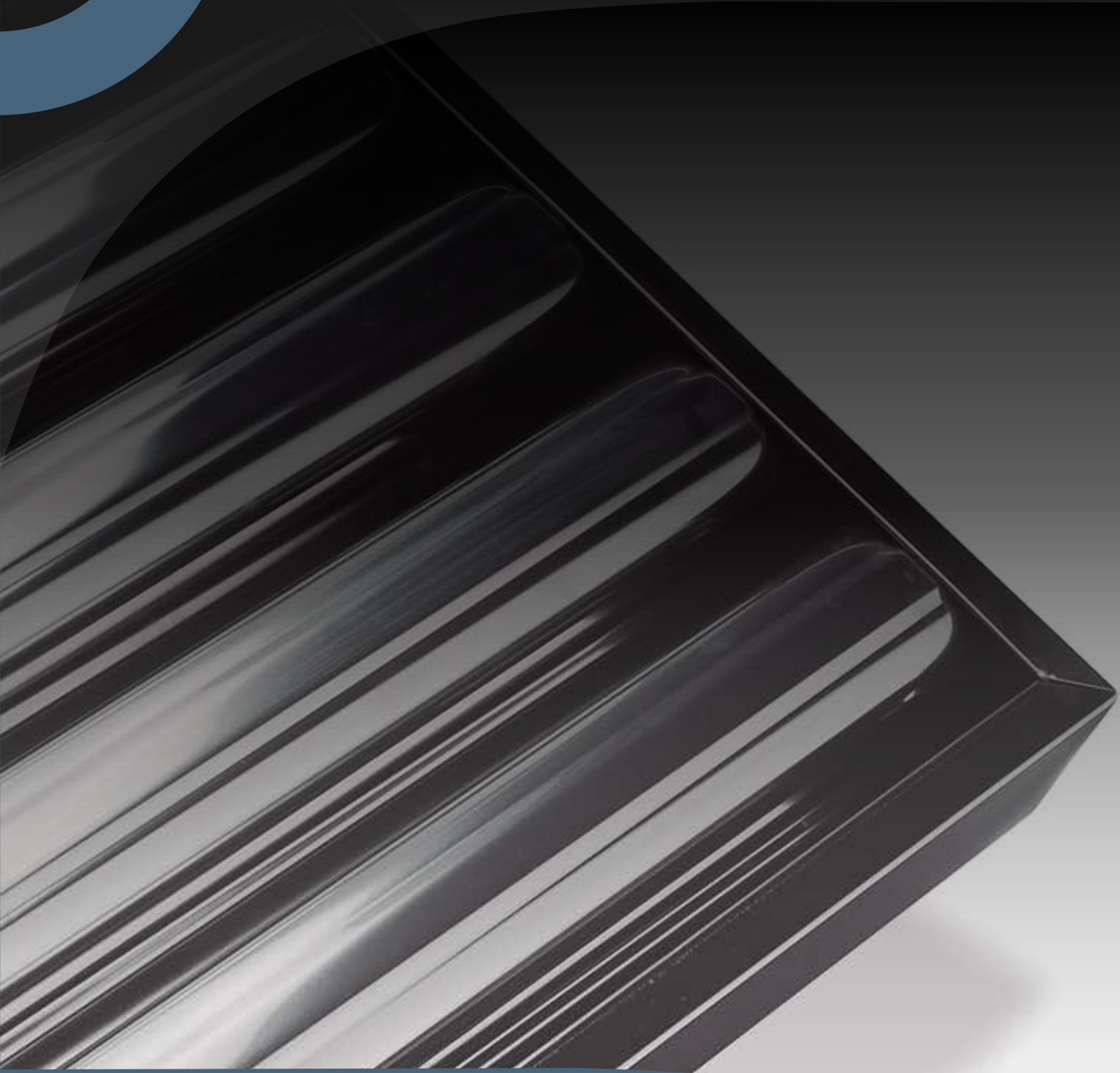

**COMPONENTES**  
COMPONENTS

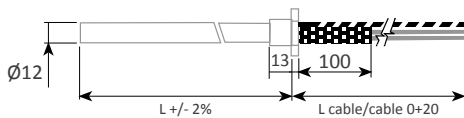

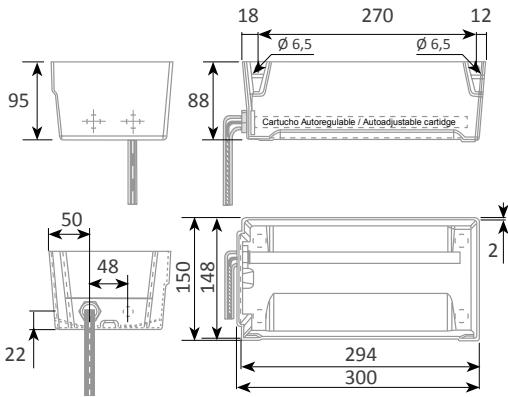

## BDE

### Bandeja evaporadora

- Bandeja fabricada en vاملpen 3026 VO CB
- Color negro
- Cartucho fabricado en AISI 304
- Cable de cobre y silicona
- Conforme a norma UNEEN 60335-1 y normativa ROHS
- Temperatura de uso: -20 a + 100°C

### Condensate evaporator

- Condensate evaporator made of vاملpen 3026 VO CB
- Black colour
- AISI 304 cartridge
- Cu and silicone cable
- In compliance with UNE EN 60335-1 and ROHS normative
- Working temperature: -20 to + 100°C

### BDE-18 / 27

230V/50hz - 180 W

Modelo Version	Código Code	Capacidad Capacity (l.)	Peso Weight (gr.)	Potencia Power (w.)
<b>BDE-18</b>	F10 7065	2,9	487	180
<b>BDE-27</b>	F10 7064	2,9	509	270

### Bandeja evaporadora

- Bandeja fabricada en aluminio refractario
- Provista de muelles anti-vibración

### Condensate evaporator

- Condensate evaporator made of refractory aluminium
- Provided with non vibrating springs

### BDE-18 C

220V - 180 W

Modelo Version	Código Code	Capacidad Capacity (l.)	Peso Weight (gr.)	Potencia Power (w.)
<b>BDE-18 C</b>	F10 3404	1,5	1.000	180

### Bandeja evaporadora

- Bandeja fabricada en aluminio refractario
- Provista de muelles anti-vibración
- BDE/16: Ciclo de evaporación: para 1 Lts. / 7 hrs.
- BDE/30: Ciclo de evaporación: para 1 Lts. / 3,15 hrs.

### Condensate evaporator

- Condensate evaporator made of refractory aluminium
- Provided with non vibrating springs
- BDE/16: Evaporation cycle: for 1 Lts. / 7 hrs.
- BDE/30: Evaporation cycle: for 1 Lts. / 3,15 hrs.

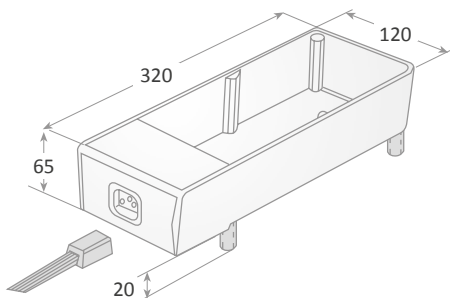

### BDE-16

220V - 160 W

Modelo Version	Código Code	Capacidad Capacity (l.)	Peso Weight (gr.)
<b>BDE-16</b>	F10 5041	1,5	1.287

### BDE-30

220V - 300 W

Modelo Version	Código Code	Capacidad Capacity (l.)	Peso Weight (gr.)
<b>BDE-30</b>	F10 1791	1,5	1.309

### BDE-300 T

220V - 300 W

Con Termostato / with Thermostat

Modelo Version	Código Code	Capacidad Capacity (l.)	Peso Weight (gr.)
<b>BDE-300 T</b>	F10 4087	1,5	1.325

# PTC

**Resistencia cartucho**

- Largo: 1 mts.

**Heater**

- Length: 1 mts.

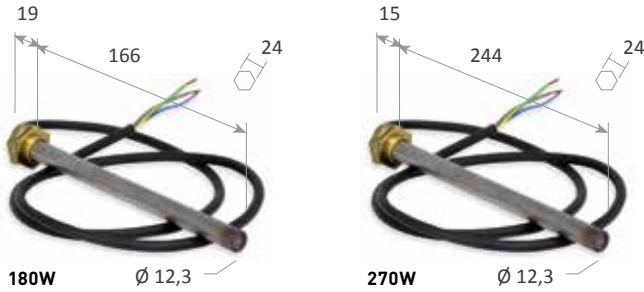

PTC			
Modelo Version	Código Code		Peso Weight (gr.)
<b>PTC-180</b>	FIO 0309	230 V <b>180 W</b>	158
<b>PTC-270</b>	FIO 0332	230 V <b>270 W</b>	161

# H-16 / 30 / 30T

**Resistencia**

**Heater**

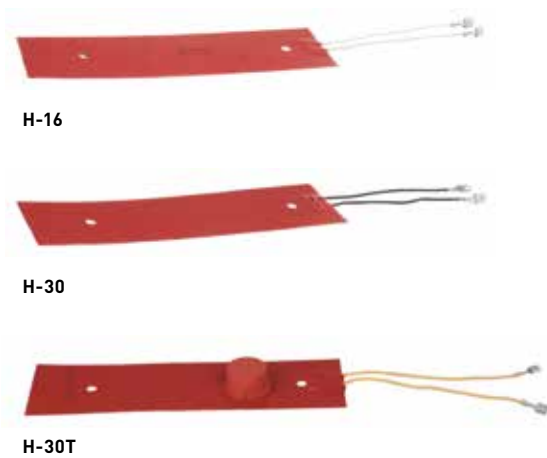

H-16 / 30 / 30T			
Modelo Version	Código Code		Peso Weight (gr.)
<b>H-16</b>	FIO 7998	230 V <b>160 W</b>	21
<b>H-30</b>	FIO 0272	230 V <b>300 W</b>	23
<b>H-30T</b>	FIO 0274	230 V <b>300 W</b> con termostato/ with thermostat	23

# SC-MAC

## Sistema calefactor para armarios y mesas calientes

El sistema de calentamiento SC-MAC se utiliza generalmente en la industria alimentaria y de restauración para asegurar el mantenimiento de una temperatura adecuada de alimentos y vajillas. Instalado en el interior de encimeras y armarios calientes, gracias al ventilador con el que está equipado, permite el correcto y continuo movimiento del aire.

Especialmente diseñado para ser instalado incluso en condiciones difíciles y en cualquier tipo de aplicación.

- Tensión de alimentación: 220/240 V
- Potencia: 1000W
- Potencia @ aire 50°: 600 W
- Longitud del cable de alimentación: 1500 mm
- Certificaciones disponibles: CE
- Producido y probado según la normativa vigente. Cumplimiento de la directiva 2014/35/UE
- Resistencia PTC de aluminio
- Termostato 30/90°C



## Heating system for hot cabinets and counters

The SC-MAC heating system is generally used in the food and catering industry to ensure the maintenance of an appropriate temperature of foods and tableware. Installed inside hot counters and cabinets, thanks to the fan with which it is equipped, it allows the correct and continuous air movement.

It is specially designed to be installed even in difficult conditions and on any kind of application.

- Supply voltage: 220/240 V
- Power: 1000 W
- Power @ air 50°: 600 W
- Supply cable length: 1500mm
- Available certifications: EC
- Produced and tested according to the current regulations. Compliance with the 2014/35/EU directive
- PTC aluminium heater
- Thermostat 30/90°C

## SC-MAC

Modelo Version	Código Code	Tipo Calefactor Heater type	Potencia Power (W.)	Medidas Measures (mm)	Capacidad Capacity (m3/h)	Zona de conexión Connection area	Peso Weight (kg.)
SC-MAC	F10 4387	Resistencia PTC de aluminio PTC Aluminium heater	1.000	240 x 210 x 96	120	Izquierda Left	3,15

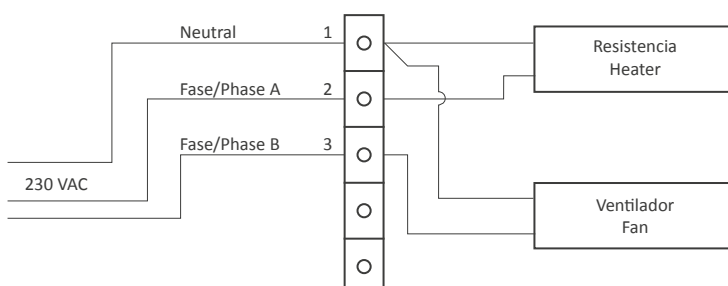

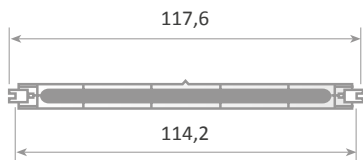

## CIRL 300 B

### Bombilla de cuarzo estándar para catering

- 300W - Baja presión

### Quartz Bulbs

- 300W - Low pressure

### CIRL 300 B

Modelo Version	Código Code		Peso Weight (gr.)
<b>CIRL 300 B</b>	F10 8432	300 W	24

- Lámparas infrarrojas halógenas de tungsteno de baja presión. El filamento es de tungsteno rodeado por un gas dosificado con halógeno y encapsulado en una manga de vidrio transparente. Estas lámparas tienen una salida infrarroja de onda corta. Calientan el objetivo usando radiación directa.

- Infrared lamps are low pressure tungsten halogen heat lamps. The filament is tungsten surrounded by a halogen dosed gas and encapsulated in a transparent quartz glass sleeve. These lamps have a short wave infrared output. They heat the objective in the path of energy using direct radiation.

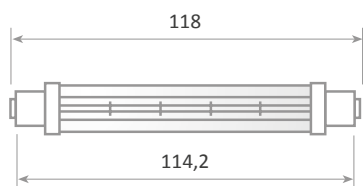

## CIRL 300 / 200 JV

### Bombillas de cuarzo revestidas

- 300W / 200W - Baja presión

### Jacketed quartz bulbs

- 300W / 200W - Low pressure

### CIRL 300 / 200 JV

Modelo Version	Código Code		Peso Weight (gr.)
<b>CIRL 300 JV</b>	F10 8433	300 W	64
<b>CIRL 200 JV</b>	F10 8434	200 W	64

- Las lámparas revestidas tienen una manga de vidrio adicional que se mueve libremente para proteger la manga interna de cualquier contacto externo que pueda causar puntos de calor y reducir la vida útil. El revestimiento evita que el vidrio caiga dentro de los alimentos (en caso de rotura). Aumenta enormemente la seguridad en los puntos de venta de alimentos.

- Jacketed lamps have an additional free-moving glass sleeve to protect the inner sleeve from any outside contact that can cause heat spots and reduce the life span. In addition the jacket stops inner glass (if shattered) from falling into food. Greatly increases safety at food outlets. Minimises chance of glass falling into food.

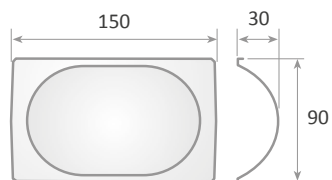

## CIRL 300 SUR

### Reflector

Modelo Version	Código Code	Peso Weight (gr.)
<b>CIRL 300 SUR</b>	F10 8436	40

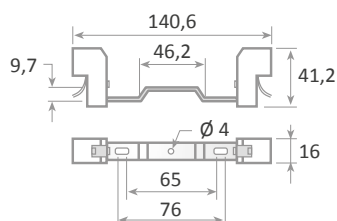

## CIRL 309

### Soporte / Holder

Modelo Version	Código Code	Peso Weight (gr.)
<b>CIRL 309</b>	F10 8435	60

# CIRL 300 / 500 PJ

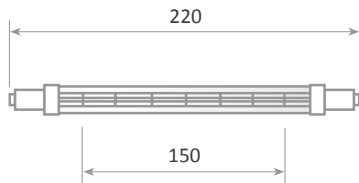

## Bombillas de cuarzo revestidas

- 300W / 500W

## Push-in jacketed quartz bulbs

- 300W / 500W

### CIRL 300 / 500 PJ

Modelo Version	Código Code		Peso Weight (gr.)
<b>CIRL 300 PJ</b>	F10 8437	300 W	102
<b>CIRL 500 PJ</b>	F10 8438	500 W	102

- Las lámparas revestidas tienen una manga de vidrio adicional que se mueve libremente para proteger la manga interna de cualquier contacto externo que pueda causar puntos de calor y reducir la vida útil. El revestimiento evita que el vidrio caiga dentro de los alimentos (en caso de rotura). Aumenta enormemente la seguridad en los puntos de venta de alimentos.
- Jacketed lamps have an additional free-moving glass sleeve to protect the inner sleeve from any outside contact that can cause heat spots and reduce the life span. In addition the jacket stops inner glass (if shattered) from falling into food. Greatly increases safety at food outlets. Minimises chance of glass falling into food.

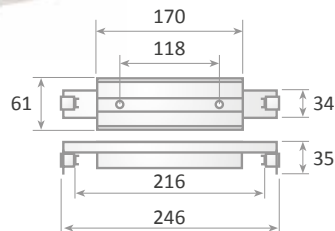

## Reflector

- Soporte y reflector para bombillas revestidas push-in

## Holder

- Holder and reflector for push-in bulbs

### CIRL 500 PHR

Modelo Version	Código Code		Peso Weight (gr.)
<b>CIRL 500 PHR</b>	F10 8439		320

## Lámpara de cerámica

## Ceramic lamp

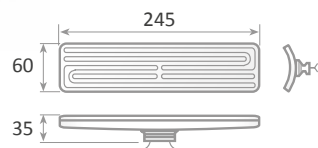

### CQCL 300 / 500

Modelo Version	Código Code		Peso Weight (gr.)
<b>CQCL 300</b>	F10 8440	300 W	256
<b>CQCL 500</b>	F10 8441	500 W	256

## Regulador de intensidad QVR/S 230 V

- Corriente: 15 A / Anti RFI: No
  - Tipo de conexión: Cable / Tipo de ángulo de fase
  - Capacidad máxima de 3.9 kw / Estándar 230V
- El instalador debe usar un disipador de calor y pasta de disipador

## Dimmer QVR/S 230 V

- Current: 15 A / Anti RFI: No
  - Connection type: Flying leads / Phase angle type
  - Maximum 3.9 kw capacity / 230V standard
- Installer should use a heat sink & heat sink paste



### CA 13202 E

Modelo Version	Código Code		Peso Weight (gr.)
<b>CA 13202 E</b>	F10 8442		150



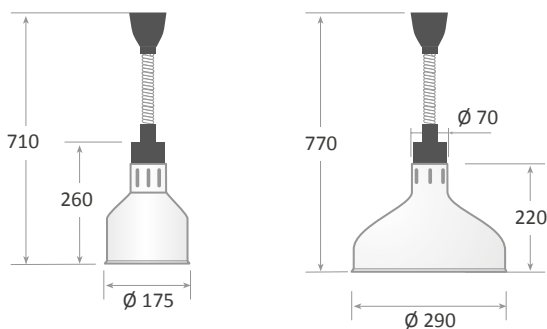

## LCA-1 / 2

### Lampara calentadora extensible

- Rango de ajuste altura: 600 - 1500 mm.
- Suministrado con roseta para techo
- Bombilla incluida

### Rise and fall heat shades

- Switch mounted on shade
- Height adjustment range: 600 - 1500 mm.
- Supplied with ceiling rose
- Bulb included

### LCA-1 / 2

Modelo Version	Código Code	Color Colour	Peso Weight (kg.)
250 W / 220-240 V. / 50-60 Hz.			
LCA-1-G	F10 0300	Gris Grey	1,65
LCA-1-N	F10 0312	Negro Black	1,65
250 W / 220 V / SPN. / 50-60 Hz.			
LCA-2-G	F10 0321	Gris Grey	1,80
LCA-2-N	F10 0337	Negro Black	1,80

## BLC-250

### Bombilla calentadora infrarrojos blanca

- Con tornillo Edison
- Apto para pantalla extensible
- 2000 hrs. vida

### Infrared heat bulb white

- With Edison screw
- Suits gantry lamps
- Suits rise and fall heat shades
- 2000 hrs. live

### BLC-250

Modelo Version	Código Code	W/V/Hz	Peso Weight (gr.)
BLC-250	F10 0301	175-250 W	163

# CPA-1

Interruptor para refrigerador

Refrigerator switch



## CPA-1

Modelo Version	Código Code	Color Colour	Peso Weight (gr.)
CPA-1	F10 6962	Blanco White	12
CPA-1	F10 6963	Negro Black	12

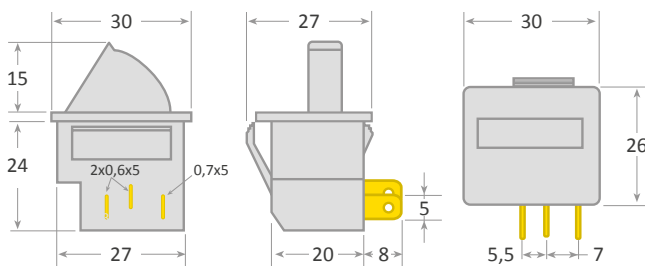

Modelo Item	Especificaciones Specifications	Notas Notes
Condiciones ambientales Environmental conditions	Temperatura Temperature - 25 ~ + 60°C  Humedad relativa Relative humidity < 95 % ( 40°C )	
Ref.	CPA-1	
Tensión nominal Related voltage	2.5A / 250V AC 5A / 125V AC	
Resistencia de contacto Contact resistance	< 50 M Ω	
Resistencia de aislamiento Insulation resistance	>100 M Ω	
Resistencia dieléctrica Dielectric strength	Aplicando AC 50Hz 1800V 3s, se evitan chispas y averías Applying AC 50Hz 1800V 3s, no spark over and break down	
Color Colour	Blanco White	
Superficie exterior Outside surface	Liso y acabado sin defectos de ampollas, fisuras, carencias de materiales, hinchazón y deformación Smooth and finished without any defects of blistering, crack, lacking of materials, swelling, and deformation	
Estilo de circuito Circuit style	30 acciones/minuto 30 times/minute	
Vida útil Lifespan	> 50000 acciones / times	A tensión y corriente nominal At rated voltage and current

		Modelo Version	Código Code	Descripción Description	Peso Weight (gr.)
		<b>IN-213-KK01</b>	FI0 8060	Interruptor impermeable on/ off color rojo Water proof switch button on/ off red colour	16
		<b>IN-213-SBL</b>	FI0 8064	Interruptor impermeable on/ off color negro Water proof switch button on/ off black colour	16
		<b>IN-213-SSL</b>	FI0 8062	Interruptor impermeable, luz color naranja Water proof switch button, light orange colour	16
		<b>IN-213-SKF</b>	FI0 8061	Interruptor impermeable ventilador color rojo Water proof switch button fan red colour	16
		<b>IN-213-SYK</b>	FI0 8063	Interruptor impermeable motor color verde Water proof switch button, motor green colour	16
		<b>IN-214-04</b>	FI0 8067	Interruptor simple on/ off color rojo Simple switch button on/ off red colour	8
		<b>IN-212-SK01</b>	FI0 8033	Interruptor on/ off color rojo Switch button, on/ off red colour	15
		<b>IN-216-01</b>	FI0 8036	Interruptor redondo on/ off color rojo Round switch button, on/ off red colour	15
		<b>IN-214-05</b>	FI0 8037	Interruptor doble on/ off color rojo Double switch button, on/ off red colour	15
		<b>IN-212-SSL</b>	FI0 8035	Interruptor luz color naranja Switch button, light orange colour	15

		Modelo Version	Código Code	Descripción Description	Peso Weight (gr.)
		<b>IN-212-SKF</b>	FI0 8034	Interrupción ventilador color rojo Switch button, fan red colour	15
		<b>IN-212-SYK</b>	FI0 8038	Interrupción motor, color verde Switch button, motor green colour	15
		<b>BN-207-S</b>	FI0 8065	Botonera con tapa transparente color negro Keypad panel with transparent cover black colour	38
		<b>BN-207-2S</b>	FI0 8066	Botonera con tapa transparente, color negro Keypad panel with transparent cover black colour	48
		<b>BN-200-S</b>	FI0 8044	Botonera color negro Keypad panel Black colour	25
		<b>BN-200-1S</b>	FI0 8030	Botonera color negro Keypad panel Black colour	35
		<b>BN-200-2S</b>	FI0 8031	Botonera color negro Keypad panel Black colour	45
		<b>BN-200-3S</b>	FI0 8032	Botonera color negro Keypad panel Black colour	50
		<b>BN-202-3S</b>	FI0 8041	Botonera color negro Keypad panel black colour	100
		<b>BN-100-D2</b>	FI0 8039	Caja de control color blanco Control box white colour	250
		<b>BN-100-D3</b>	FI0 8040	Caja de control color blanco Control box white colour	250

# AD-100



### Caja de conexión

- Caja de conexiones estanca
- Diseñada para conexiones de aparatos frigoríficos (10A – 400V) de cualquier tipo (vitrinas , armarios, mesas frías)
- Con esta caja se evita las conexiones aéreas las cuales quedan expuestas en los montajes estándar, que puede ser dañadas por distintos factores
- Contiene una entrada eléctrica y 4 salidas para las distintas maniobras de las maquinas, cada salida tiene 4 conectores
- Viene preparada con soportes para fijar al cuerpo del aparato
- Protección eléctrica IP-30

### Connection box

- Sealed jack box
- Designed for connections of refrigerating devices (10A – 400V) of any type (display cabinets, counters, cool tables)
- This box avoids the air connections that remain exposed in standard assemblies and which can be damaged by several factors
- It has an electric inlet and 4 outlets for the several operations of the machines
- Each outlet has got 4 connections
- It is provided with holders to fix it to the device body.
- IP-30 electric protection

## AD-100

Modelo Version	Código Code	Peso Weight (gr.)
AD-100	F10 4081	100

# C-ALL BP / BC / BR

## Lámparas colgantes LED

- Lámparas iluminación led especialmente diseñadas para instalaciones de productos lácteos, de pastelería, carnicería y charcutería
- Led 30W
- Para más información, consultar

## Pendant LED light

- Lamps led lighting specially designed for dairy products, bakery, butcher shop and delicatessen
- Led 30W
- For more information, consult



## C-ALL BP / BC / BR

Modelo Version	Código Code	Descripción Description	Peso Weight (kg.)
C-ALLBP	F10 3223	Blanco puro Tulipa color azul mate Pure white Mate blue lamp cover	1,18
C-ALLBC	F10 3224	Blanco cálido Tulipa color amarillo mate Warm white Mate yellow lamp cover	1,18
C-ALLBR	F10 3225	Blanco rosado Tulipa color rojo mate Pink white Mate red lamp cover	1,18

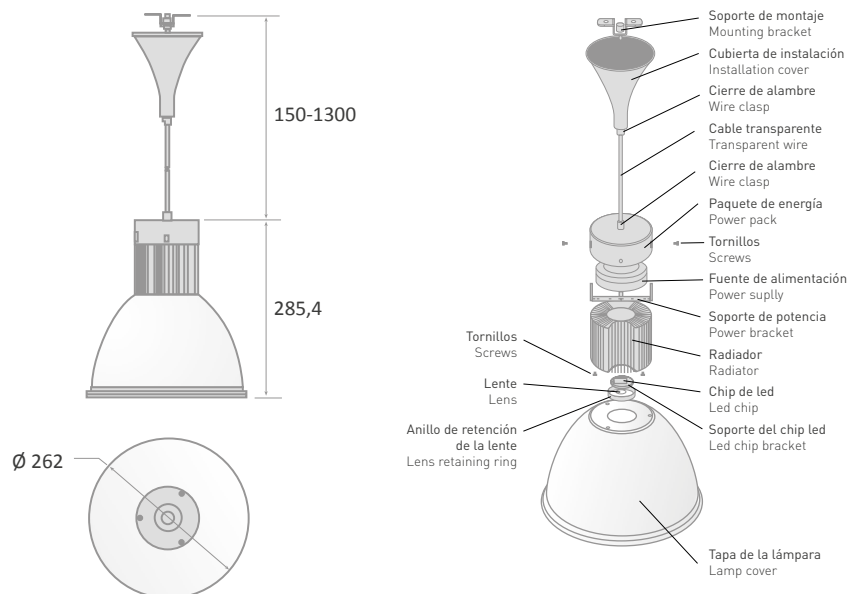

# T8 / B7

## LED

Características del producto:

- Fuente de luz SMD 2835 de bajo consumo, supone un ahorro de 80% de energía respecto de lámparas incandescentes.
- Protección del medio ambiente: No contiene mercurio, plomo ni sustancias peligrosas contaminantes; ni rayos ultravioletas o infrarrojos, para evitar daños al cuerpo humano.
- Larga vida útil: hasta 50.000 horas.
- Nivel de protección: IP65, puede utilizarse en ambientes muy húmedos o con vapor ... también soporta agua pulverizada.
- Cuerpo de la lámpara: Placa de aluminio y carcasa en dos colores, la parte superior permite un ángulo de iluminación de 120°.
- No necesita adaptador

Aplicaciones:

- Para montaje de iluminación en congeladores, refrigeradores, estanterías expositoras de: flores , pescados, carnes, charcutería, comidas, supermercados o almacenes.

## LED

Product Features:

- Energy saving: The low power 2835 SMD as light source, 80 % energy saving than incandescent.
- Environmental Protection: No mercury, lead and hazardous substances no environmental pollution no infrared ultraviolet to avoid harm to the human body, its green lighting product.
- Long lifespan: The life of up 50.000 hours.
- Level of protection: IP65, can be used in the environment of water mist, water vapour and water spray.
- Using the PC for the lamp body, Two color injection, above the lamp beads are light-emitting surface, Beam Angle is 120°
- No adapter required

Applications:

- For assembling in fresh lighting, freezer, refrigerator, shelves , flowers and fish, meat, deli , dining table , supermarket refrigeration reserve, etc.

### Especificaciones técnicas / Technical specifications

	Tipo/ Type	L 600	L 900	L 1200	L 1500
<b>T-8</b>	Potencia nominal / Rated power	9W	13W	18W	22W
	Consumo de energía / Power consumption	9W+/-1W	13W+/-1W	18W+/-1.5W	22W+/-1.5W
	Voltaje de entrada / Input voltage	AC85-265 V			
	Cantidad LED / LED quantity	48	77	108	137
<b>B7</b>	Tipo/ Type	L 600	L 900	L 1200	L 1500
	Potencia nominal / Rated power	9W	13W	18W	22W
	Consumo de energía / Power consumption	9W+/-1W	13W+/-1W	18W+/-1.5W	22W+/-1.5W
	Voltaje de entrada / Input voltage	AC85-265 V			
	Cantidad LED / LED quantity	48	77	108	137

Fuente de LED / LED source	SMD2835 ( 2700-7000K)	
Eficacia luminosa de LED / LED luminous efficiency	90-100lm/W -/+ 10%	La protección opaca tiene una baja eficiencia luminica pero una alta transmitancia de luz. Milky cover has low Luminous Efficiency but high light transmittance
Flujo luminoso LED / LED Luminous Flux	900lm/W -/+ 10%	1750lm/W -/+ 10%
Eficiencia luminaria / Luminary efficiency	>85%	
Uniformidad de iluminación / Illumination uniformity	>0.8	
Temperatura de color correlacionada / Correlated colour Temperature	2700K-7000K	
Índice de reproducción cromática / Colour rendering Index	Ra>80	
Ángulo del haz / Beam Angle	120°	
Grado de protección / Degree of protection	IP 65	



**T8 - LED**  
Tubo / Tube



**B7 - LED**  
Regleta / Terminal strip



## T-8

Tubo / Tube

Medida Measure (mm)	Blanco cálido Warm white		Blanco puro Pure white		Blanco rosado para carne Pink white for meat		Peso Weight (gr.)
	Código Code	Ref. Ref.	Código Code	Ref. Ref.	Código Code	Ref. Ref.	
<b>600</b>	F10 0820	T8-600 BC	F10 0835	T8-600 BP	F10 0840	T8-600 BR	150
<b>900</b>	F10 0826	T8-900 BC	F10 0836	T8-900 BP	F10 0841	T8-900 BR	225
<b>1200</b>	F10 0828	T8-1200 BC	F10 0838	T8-1200 BP	F10 0842	T8-1200 BR	300
<b>1500</b>	F10 0834	T8-1500 BC	F10 0839	T8-1500 BP	F10 9969	T8-1500 BR	375

## B7

Regleta / Terminal strip

Medida Measure (mm)	Blanco cálido Warm white		Blanco puro Pure white		Blanco rosado para carne Pink white for meat		Peso Weight (gr.)
	Código Code	Ref. Ref.	Código Code	Ref. Ref.	Código Code	Ref. Ref.	
<b>600</b>	F10 4136	B7-600 BC	F10 4140	B7-600 BP	F10 4144	B7-600 BR	95
<b>900</b>	F10 4137	B7-900 BC	F10 4141	B7-900 BP	F10 4145	B7-900 BR	125
<b>1200</b>	F10 4138	B7-1200 BC	F10 4142	B7-1200 BP	F10 4146	B7-1200 BR	150
<b>1500</b>	F10 4139	B7-1500 BC	F10 4143	B7-1500 BP	F10 4147	B7-1500 BR	175



# LCE

LCE-6225

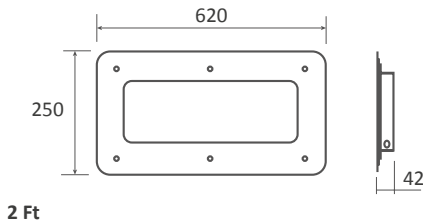

LCE-1225

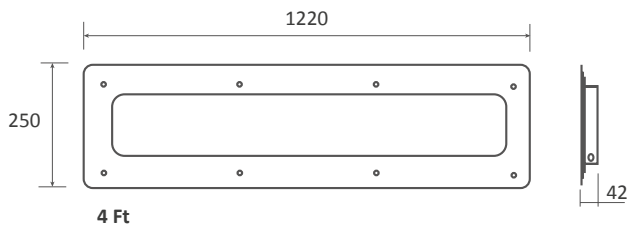

## Luminarias

### Ventajas

- Tubos LED probados en el mercado durante 2 años
- 3 tubos por unidad
- Dura hasta 50.000 horas

### Características:

- Ajuste sencillo con solo 6/8 tornillos Pozi M6 x 20 mm (incluidos)
- Lámpara empotrable delgada (42mm de profundidad)
- Controladores integrados en tubos LED (luz blanca 5500k)
- Frente de acero satinado con 4mm. vidrio de seguridad templado
- Precableado con cable de 2 pies y conector Klik instalado
- Eficiencia energética con carga máxima 15 W.
- Unidad eficiente hasta 80°C ambiente.
- Unidades garantizadas por 3 años.
- Certificación CE y clasificación frontal IP65

## Canopy lamps

### Advantages

- LED tubes tried and tested for 2 years
- 3 tubes per unit
- Last up to 50.000 hours

### Features:

- Easy fit with just 6/8 M6 x 20mm Pozi screws ( supplied )
- Slim recessed lamp unit ( 42mm deep )
- Drivers integrated into LED tubes ( 5500k white light )
- Stainless steel front with 4mm. tempered safety glass
- Pre-wired with 2ft cable and Klik connector fitted
- Energy efficient with maximum load 15 W
- Unit efficient up to 80°C ambient
- Units guaranteed for 3 years
- CE certified and front rated IP65

## LCE

Modelo Version	Código Code	Medidas exteriores Outside Dimensions (mm) L x A x D	Medidas recortadas Cut-out dimensions (mm) L x A	Peso Weight (kg.)	Calificación máxima de lux 1200 mm por encima de la superficie de cocción Maximum lux rating 1200mm above cooking surface ( mm )
LCE-6225	F10 0525	620 x 250 x 42	584 x 195	3,5	530 lux
LCE-1225	F10 0526	1220 x 250 x 42	1184 x 195	6,4	727 lux

# LPCE

## Lámparas led para campanas

- Rango lux: a 1,2 m, la proyección de luz sobre un cuadrado de 900 mm proporciona una clasificación promedio de 257 lux (máx. 417 lux, mín. 140 lux)
- Temperaturas de color del LED disponibles: blanco frío (4000 K) o blanco cálido (2700 K)
- Regulable, con clasificación IP65 y totalmente calificada con resistencia al fuego de 30, 60 y 90'
- Viene precableado con un conector Click Flow de 2 partes
- Vida útil del LED: 25,000 horas con 2 años de garantía
- Acabado del bisel: cromo satinado, coincide con el dosel
- Corte: 60 mm, espesor del techo 1-40 mm
- 4.8W. Red conectada y no requiere tierra
- Se recomienda instalar las lámparas con una separación de 500-600 mm entre centros
- Clip separador de 20 mm disponible bajo pedido
- Flujo luminoso total: 400-450lm
- Ángulo de haz: 40°



## Hood led downlighters

- Lux Rating: At 1.2m the light projection onto a 900m square gives an average rating of 257 lux (max. 417 lux, min. 140 lux)
- LED Colour Temperatures available: Cool white (4000K) or warm white (2700K)
- Dimmable, IP65 rated and fully 30, 60 and 90' fire rated
- Comes pre-wired with 2 part Click Flow connector
- LED Lifetime: 25,000 hours with 2 year warranty
- Bezel Finish: Satin chrome, matches canopy
- Cut out: 60mm, ceiling thickness 1-40mm
- 4.8W. Mains connected and no earth required
- Recommend lighters fitted 500-600mm centres apart
- 20mm spacer clip available on request
- Total Luminous Flux: 400-450lm
- Beam angle: 40°

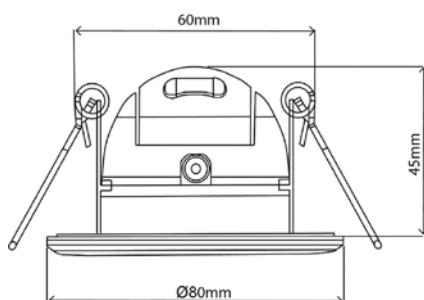

## LPCE

Modelo Version	Código Code	Color Colour	Peso Weight (gr.)
LPCE-2700	F10 0343	Blanco cálido Warm white	208
LPCE-4000	F10 0344	Blanco frío Cool white	208

## ADVERTENCIA DE CALOR AMBIENTE

Las lámparas deben tener un espacio de 50 mm a su alrededor y un espacio libre de 20 mm por encima. Temperatura ambiente de funcionamiento máxima 80° C; de lo contrario, la vida útil de la lámpara se reducirá y la garantía se invalidará

## AMBIENT HEAT WARNING

Lamps must have 50mm space around them and 20mm clearance above. Operating ambient temperature maximum 80°C, otherwise lamp life will be reduced and warranty invalidated

# LPCN

## Lámparas led

- Especificaciones de la fuente de luz: 2835-0,5w
- Pantalla LED: 8
- LED LM: 60-65LM
- Forma de onda LED: 650
- Tensión nominal: 220-240V 50/60Hz
- Corriente nominal: 0,03A +-2%
- Potencia nominal: 4W +-2%
- Arranque por baja presión: 180V
- Prueba de alto voltaje: Ac 3000v
- Temperatura de color: 4000K
- Factor de potencia: 5,7IP
- Temperatura de trabajo de la PCB: 60°C+-2%
- Eficiencia de la fuente de luz: 95%
- Temperatura ambiente de trabajo: -25—85°C
- Clasificación de fuego del plástico: V-0
- Material de la lente: lente
- Requisitos de alambre: alambre de cubierta
- Pin terminal: EL
- Caja metálica: Acero inoxidable 201
- Resistencia al impacto: 15 KG
- Ángulo del circlip: el ajuste según el ángulo del rugido es generalmente inferior a 40 grados

## Led downlighters

- Light source specifications: 2835-0.5w
- LED display: 8
- LED LM: 60-65LM
- LED waveform: 650
- Rated voltage: 220-240V 50~60Hz
- Rated current: 0.03A +-2%
- Rated power: 4W +-2%
- Low pressure start: 180V
- High voltage test: Ac 3000v
- Colour temperature: 4000K
- Power factor: 5.7IP
- PCB working temperature: 60°C+-2%
- Light source efficiency: 95%
- Working environment temperature: -25—85°C
- Plastic fire rating: V-0
- Lens material: lens
- Wire requirements: Sheath wire
- Terminal pin: EL
- Metal case: Stainless steel 201
- Impact resistance: 15KG
- Circlip angle: Adjusting according to the roar angle is generally less than 40 degrees



## LPCN

Modelo Version	Código Code	Peso Weight (gr.)
LPCN	F10 0345	69

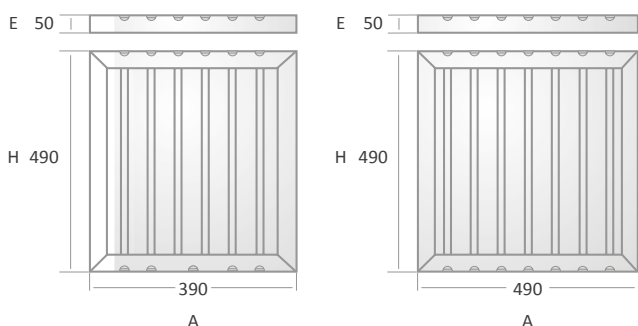

A = Ancho / Width  
H = Altura / Height  
E = Espesor / Thickness

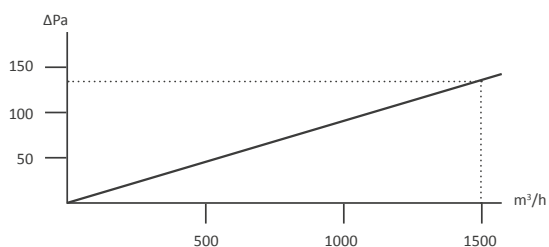

# FLI / FLF

## Filtros de lamas

- Acero Inoxidable AISI 304

## Grease baffle filter

- AISI 304 Stainless Steel

### FLI / FLF - 39 / 49

Modelo Version	Código Code	Medida (Ancho x Altura x Espesor) Measure (Width x height x Thickness)	Peso Weight (kg.)
<b>FLI-39</b>	F10 3486	390 x 490 x 50	1,90
<b>FLF-39</b>	F10 3474	390 x 490 x 50	1,90
<b>FLI-49</b>	F10 5560	490 x 490 x 50	2,35
<b>FLF-49</b>	F10 5562	490 x 490 x 50	2,05

Eficacia gravimétrica / Arrestance efficiency  
75%

Pérdida de carga inicial-final / Pressure drop  
140Pa (490x490x48mm, 20x20x2in)

Caudal / Airflow  
1500m³/h (490x490x48mm, 20x20x2in)

# DV-30-IX

## Válvula desengrase para filtro

- Fabricado en acero Inoxidable 18/8

## Drain valve

- Manufactured in stainless steel 18/8

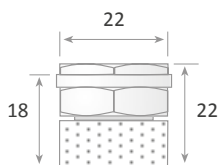

### DV-30-IX

Modelo Version	Código Code	Peso Weight (gr.)
<b>DV-30-IX</b>	F10 5133	35

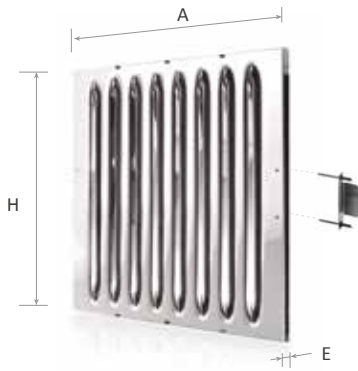

A = Ancho / Width  
 H = Altura / Height  
 E = Espesor / Thickness

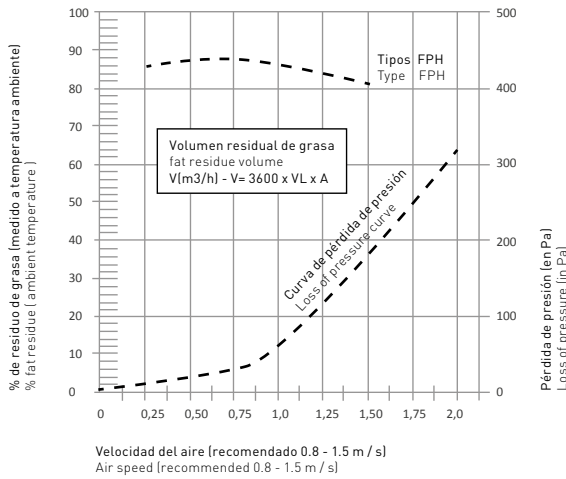

# FLF

## Filtros de lamas

- Acero Inoxidable
- Ferrítico

## Grease baffle filter

- Stainless Steel
- Ferritic

### FLF

Modelo Version	Código Code	Medida (Ancho x Altura x Espesor) Measure (Width x height x Thickness) A x H x E	Peso Weight (kg.)
<b>FLF-5050</b>	F10 3440	500 x 500 x 20	2
<b>FLF-4545</b>	F10 3441	450 x 450 x 20	1,65
<b>FLF-4040</b>	F10 3442	400 x 400 x 20	1,30
<b>FLF-5040</b>	F10 3443	500 x 400 x 20	1,60
<b>FLF-4050</b>	F10 0367	400 x 500 x 20	1,60
<b>FLF-5030</b>	F10 3444	500 x 300 x 20	1,25
<b>FLF-3050</b>	F10 3445	300 x 500 x 20	1,25

# DA-100

## Difusor de aire

## Spot coder

### DA-100

Modelo Version	Código Code	Peso Weight (gr.)
<b>DA-100</b>	F10 3847	50

# DAR / DAA

Desagüe PVC

PVC Drain

DAR

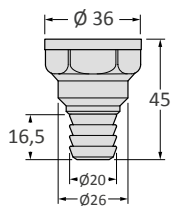

DAA

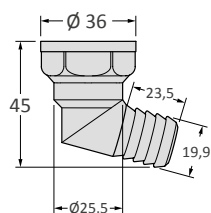

DPL

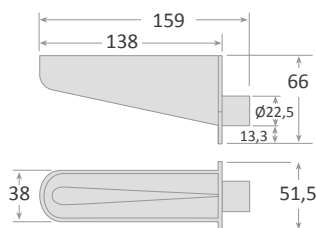

# DPS

Desagüe con sifón

Siphoning drain

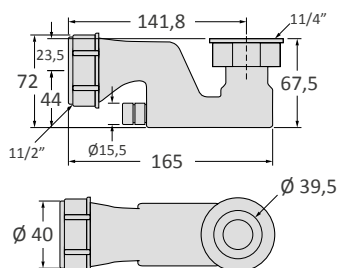

## DAR / DAA

Modelo Version	Código Code	Peso Weight (gr.)
DAR	F10 9208	11
DAA	F10 9209	16
DPL	F10 0302	40

## DPS

Modelo Version	Código Code	Peso Weight (gr.)
DPS	F10 9210	111

# CC / CL / M / ML

Desagüe nylon con tuerca valona y junta de estanqueidad

Nylon drain tube with nut and water tightness joint

CC

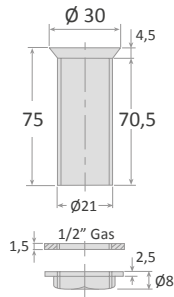

CL

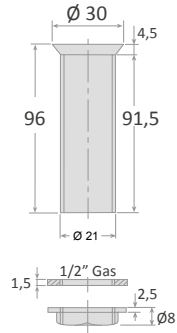

M

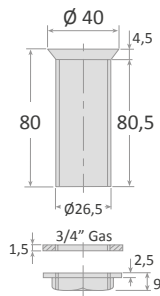

ML

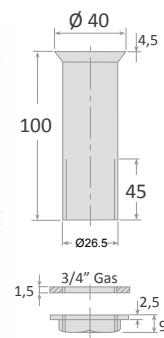

## CC / CL / M / ML

Modelo Version	Código Code	Peso Weight (gr.)
CC	F10 0877	14
CL	F10 0876	18
M	F10 0878	18
ML	F10 0879	24

CC-CL

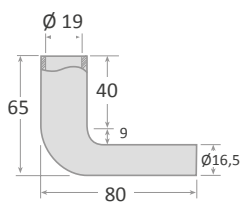

M-ML

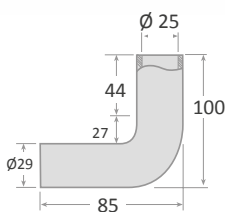

# CC-CL / M-ML

Codo desagüe fabricado en caucho semirígido de color negro

Drain tube made of black semi-rigid rubber

## CC-CL / M-ML

Modelo Version	Código Code	Peso Weight (gr.)
CC-CL	F10 0880	28
M-ML	F10 1937	18

# TV

Tapa ventilador

Fan guard

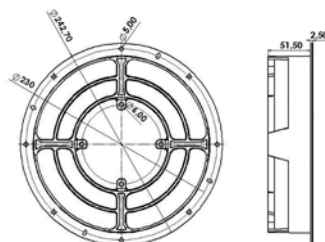
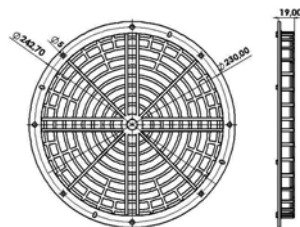
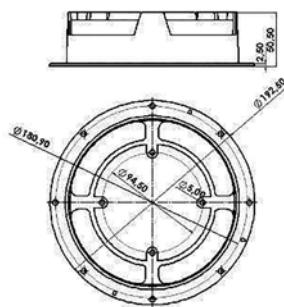
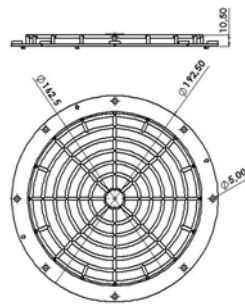

TV		
Modelo Version	Código Code	Peso Weight (gr.)
15CM TV-203-01	F10 8042	57,5
15CM TV-203-02	F10 8043	57,5
20CM TV-204-01	F10 8045	100
20CM TV-204-02	F10 8046	100



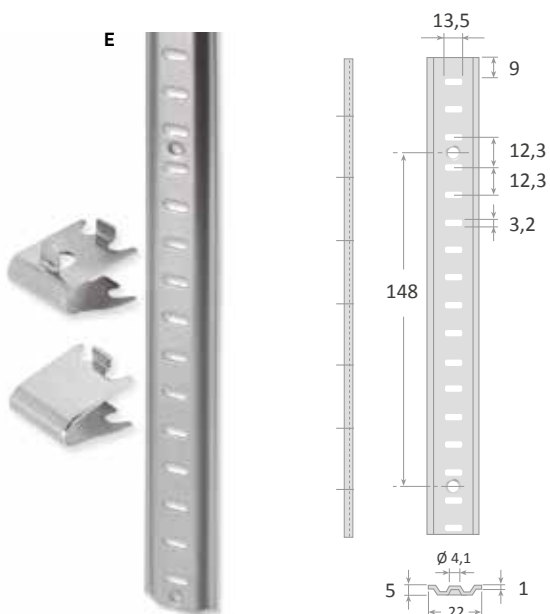

## E

### Cremallera fabricada en AISI 304

- 1mm espesor

### AISI 304 Stainless steel rack

- 1mm thickness

E			
Código Code	Medida Measure (mm)		Peso Weight (gr.)
FI0 0370	1000	22 x 4,5	162
FI0 0371	1500	22 x 4,5	216
FI0 0372	2000	22 x 4,5	330

### Soporte AISI 304

- 1mm espesor

### AISI 304 Support

- 1mm thickness

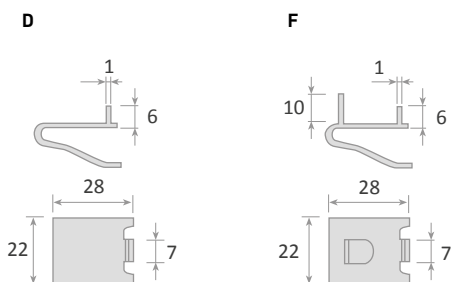

## D / F

Modelo Version	Código Code	Peso Weight (gr.)
D	FI0 0382	11
F	FI0 0381	11

## A / B

### Soporte inoxidable

- 1mm espesor

### Stainless steel Support

- 1mm thickness

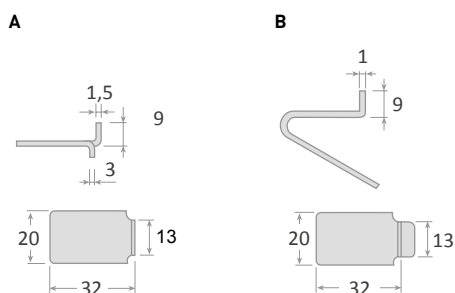

## A / B

Modelo Version	Código Code	Material Material	Peso Weight (gr.)
A	FI0 0376	Acero cincado Galvanised steel	8
B	FI0 0380	Acero inoxidable Stainless steel	10

Nota: soportes A y B no son validos para cremallera E  
Note: brackets A and B are not valid for rack E.

# MICROELEBAR

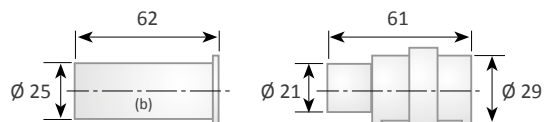
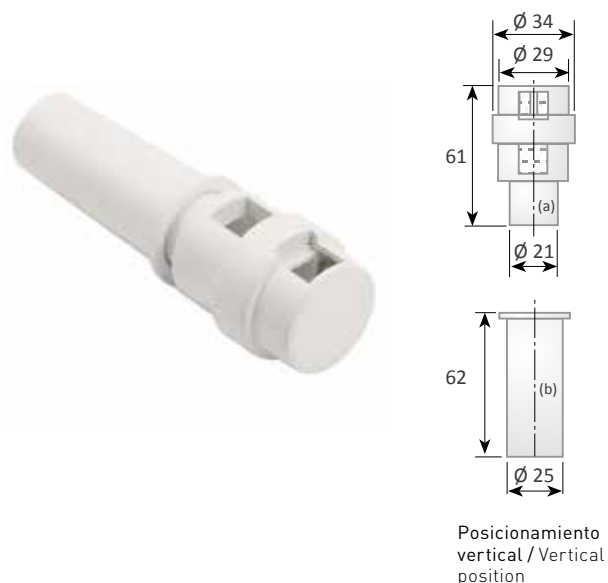

Posicionamiento Horizontal / Horizontal position

## Válvula compensación

- Aplicable en armarios con capacidad max. 2000 litros
- Posibilidad de instalación vertical u horizontal
- Operativa entre +10 / -18°C

Nota: En posicionamiento horizontal las aletas deben quedar en la parte inferior mirando hacia abajo. Posibilidad de inyectado del mueble con el cilindro (b) con el consiguiente ahorro de tiempo en el montaje.

## Compensating valve

- To be applied in boxes with 2000 litres as max. capacity
- Possibility of vertical or horizontal position when mounting

- Operation between + 10 / -18°C

Note: In horizontal position the fins should remain in the lower part facing down. Possibility of injecting the cylinder (b) with the consequent time saving when mounting

## MICROELEBAR

Modelo Version	Código Code	Peso Weight (gr.)
Micro-elebar	F10 9419	30

# VE-5557

## Válvula de equilibrado de presión para muebles frigoríficos

- Diseñado para espesor de pared 50mm
- Rápida compensación de presión
- A prueba de corrosión e insectos
- Mantiene el aislamiento
- Flujo de aire bidireccional
- 52mm de diámetro
- PVC y filtro de acero inoxidable

## Pressure relief vent port for reach-in refrigerators and freezers

- Designed for 50mm wall thickness
- Fast pressure equalization
- Corrosion and vermin proof
- Insulated construction
- Two-way air flow
- 52mm diameter
- PVC and stainless steel filter

## VE-5557

### Válvula equilibrado de presión / Pressure balancer

Modelo Version	Código Code	Espesor puerta Door thickness	Peso Weight (gr.)
VE-5557	F10 9420	52mm	28

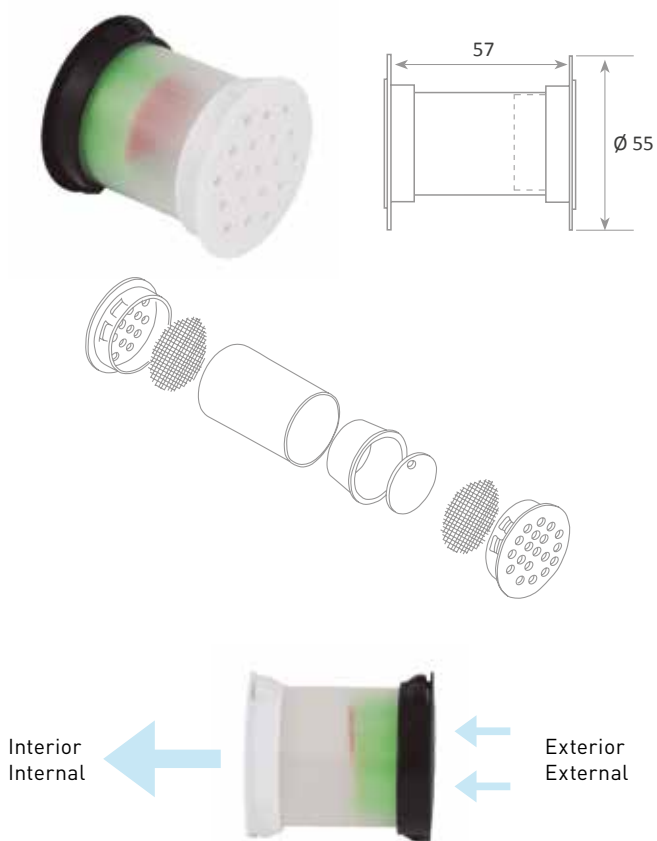

# PVR-4733

## Puerta para vitrina refrigerada

- Fabricada en ABS con burlete magnético
- Se suministra con bisagras y ejes
- Color gris claro

## Door for refrigerated cabinet

- Made of ABS with magnetic gasket
- Supplied with hinges and shafts
- Light grey colour



### PVR-4733

Modelo Version	Código Code	Peso Weight (kg.)
PVR-4733	F10 3268	2

Hueco de luz / Counter hole  
457 x 300 mm.

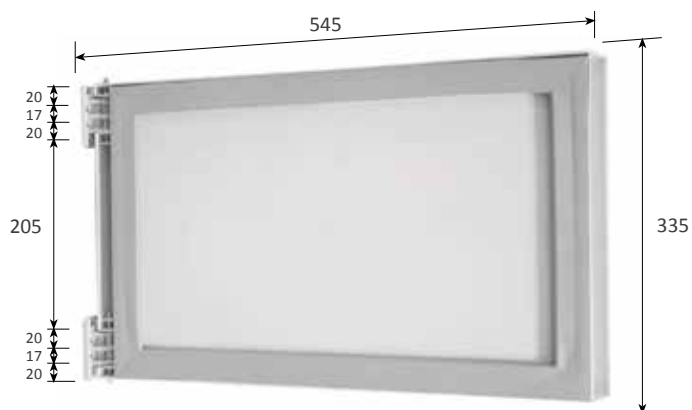

# PAC/P

Perfiles para marcos y puertas de cristal

Profiles for frames and glass doors

**Iceberg**  
Modelo todo vidrio / Total glass model

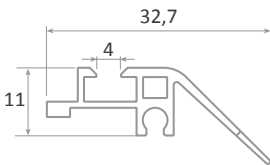

F10 3124

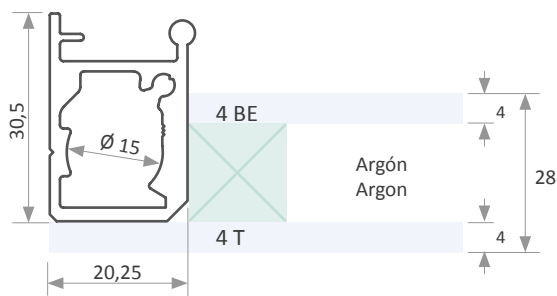
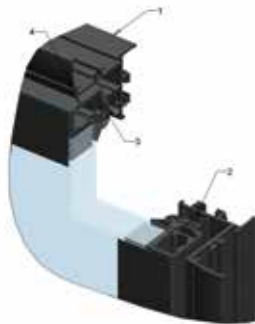

F10 3069

**Iceberg**  
Modelo estándar / Standard model

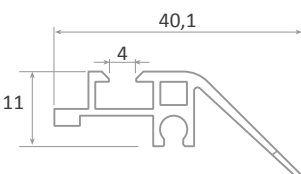

F10 9763

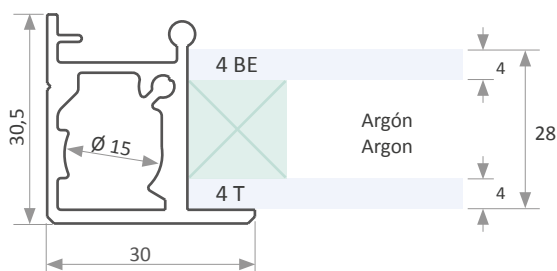
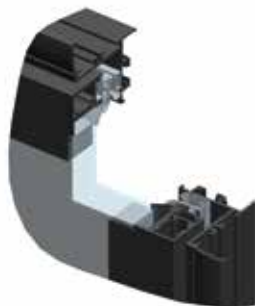

F10 4340

## PAC/P

Modelo Version	Código Code	Material Materiel		Tira Strip (mts.)
<b>Modelo todo vidrio / Total glass model</b>				
<b>PAC/P- 1</b>	F10 3124	PVC Negro Black PVC	Para marco For frame	3
<b>PAC/P- 2</b>	F10 3069	Aluminio Plata Silver aluminium	Para marco For frame	3
<b>Modelo estándar / Standard model</b>				
<b>PAC/P- 3</b>	F10 9763	PVC Negro Black PVC	Para cristal For glass	3
<b>PAC/P- 4.2</b>	F10 4340	Aluminio Plata Silver aluminium	Para cristal For glass	3



## Escuadras / Brackets

Modelo Version	Código Code	Material Materiel	Conjunto escuadras Set of brackets
<b>EP-4.2/01</b>	F10 4341	Hierro zincado Zinc coated iron	Escuadras para marco / Frame brackets  Escuadras para puerta / Door brackets (8un.)



## DPN / DPC

### Dispensador de platos

- Acero Inoxidable 18/8
- Capacidad para 45 platos

### Plate Dispenser

- 18/8 Stainless Steel
- Capacity for 45 dishes

### DPN / DPC

Dispensador de platos / Plate Dispenser Ø 18-26

Modelo Version	Código Code	Mod.	Peso Weight (kg.)
<b>DPN-1826</b>	FI0 6919	Neutro Neutral	11
<b>DPC-1826</b>	FI0 6918	Calefactado Heater	11,5

Dispensador de platos / Plate Dispenser Ø 24-32

Modelo Version	Código Code	Mod.	Peso Weight (kg.)
<b>DPN-2432</b>	FI0 7015	Neutro Neutral	11
<b>DPC-2432</b>	FI0 7016	Calefactado Heater	11,5

### TPD

Tapa / Cover

Modelo Version	Código Code	Diámetro Diameter (Ø mm.)	Peso Weight (gr.)
<b>TPD-1826</b>	FI0 6901	325	265
<b>TPD-2432</b>	FI0 6902	400	435

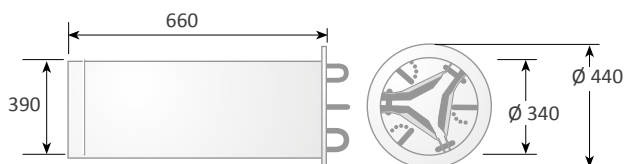
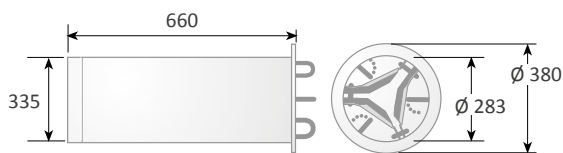

DPC



# SC

## Dispensador de vasos

- Acero Inoxidable 18/8
- Permite regular la boca para distintos diámetros de vaso
- Longitud del tubo: 585 mm

## Cup Dispenser

- 18/8 Stainless Steel
- For different glass diameter
- Tube length: 585 mm

Ø Hueco / Hole

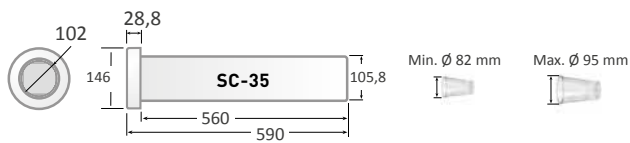
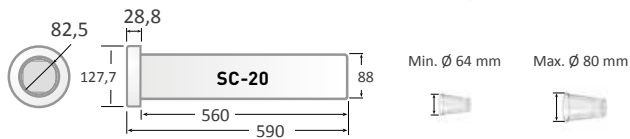
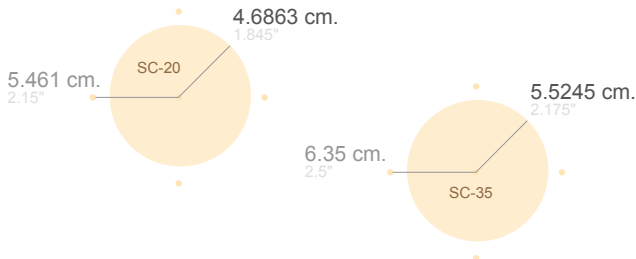

## SC

Modelo Version	Código Code	Medida agujero Hole size (mm.)	Aro exterior Outer collar (mm.)	Peso Weight (kg.)
SC-20 RS	F10 5581	93,7	111,1	1,3
SC-35 RS	F10 5580	130,2	149,2	1,6

# C5250C

## Dispensador de vasos

- Dispensador fabricado en plástico de alto impacto para distintos diámetros de vasos: Ø Min. 50 mm. - Ø Max. 85 mm.
- Vaso: 118 - 710 mL.
- Diámetro del borde: 62-92 mm.
- Longitud del tubo: 603 mm.

## Cup Dispenser

- Cup dispenser manufactured in high-impact plastic for different cup diameter: Ø Min. 50 mm. - Ø Max. 85 mm.
- Glass: 118 - 710 mL.
- Cup rim diameter : 62-92 mm.
- Tube length: 603 mm.



Ø Hueco / Hole

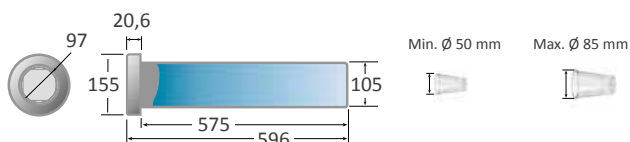
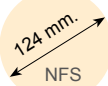

## C5250C

Modelo Version	Código Code	Peso Weight (kg.)
C5250C	F10 3214	1,4

## DS-1710

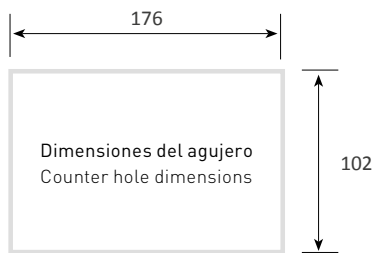

### Dispensador servilletas

- Capacidad: 250 servilletas
- Dimensiones (mm): 310 x 170 x 99 (LxWxH)
- Recorte-Hueco: 176 x 102 mm.

### Napkins dispenser

- Capacity: 250 napkins
- Dimensions (mm): 310 x 170 x 99 (LxWxH)
- Hole: 176 x 102 mm.

### DS-1710

Modelo Version	Código Code	Material Material	Peso Weight (kg.)
DS-1710	F10 8882	Acero Inoxidable Stainless Steel	3,12



## CK

### Porta comandas

### Check racks

### CK

Modelo Version	Código Code	Medida Measure (mm)	Peso Weight (gr.)
CK-6424A	F10 9637	51x610x19	405
CK-6548A	F10 9638	51x1220x19	825





## TJ

### Barra divisoria fabricada en acero inoxidable AISI 430

- Acabado pulido brillante

### Stainless steel divider bar AISI 430

- Mirror polished finish

## TJ

Modelo Version	Código Code	Descripción Description	Largo Large (mts.)	Peso Weight (gr.)
TJ-01	FI0 8210	Lateral End	2,1	-
TJ-02	FI0 8209	Central	2,1	-



## SMB

### Soporte correbandejas

- Acero Inoxidable 18/8
- Soporte correbandejas plegable en acero inoxidable para tubo de 25 mm.
- Sobresale 57 mm. de la pared en su posición cerrada

### Tray slide bracket

- 18/8 Stainless Steel
- Tray slide bracket. Fold down. Stainless steel for tube 25 mm.
- Bracket protrudes 57 mm. from wall/unit in closed position

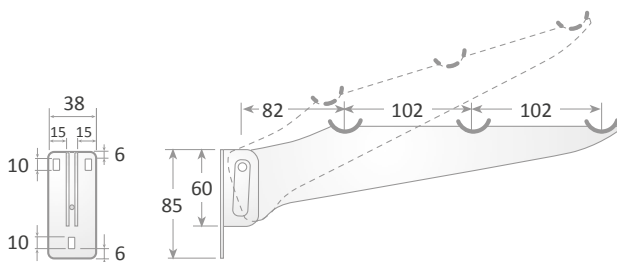

## SMB

Modelo Version	Código Code	Material Material	Peso Weight (gr.)
SMB	FI0 0305	Acero Inoxidable Stainless Steel	585



SCI-1

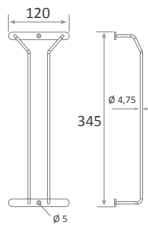
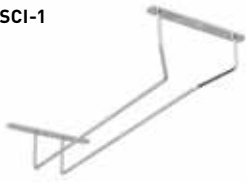

SCI-5

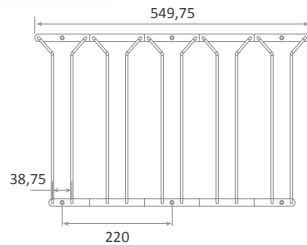
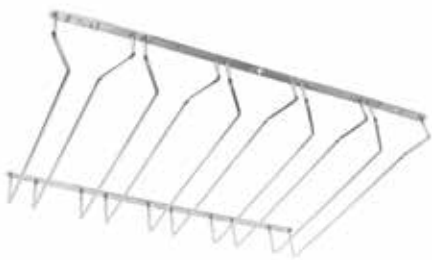

SCI-6

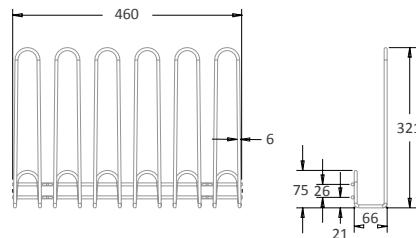

# SCI

## Soporte para copas

- Acero Inoxidable 18/8

## Glass rack

- 18/8 Stainless Steel

### SCI

Modelo Version	Código Code	Material Material		Peso Weight (gr.)
SCI-1	FI0 0548	Acero Inox Stainless Steel	Para 1 fila de copas For 1 row of cups	183
SCI-5	FI0 0547	Acero Inox Stainless Steel	Para 5 filas de copas For 5 rows of cups	876
SCI-6	FI0 0531	Acero Inox Stainless Steel	Para 5 filas de copas For 5 rows of cups	1420

# PIG / PIP

Estantes varilla en acero inoxidable

Stainless steel grid

PIGN 1/1

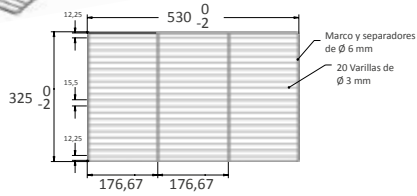

PIGN 2/1

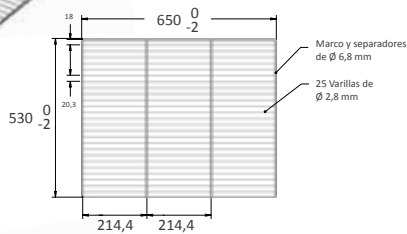

PIP6040

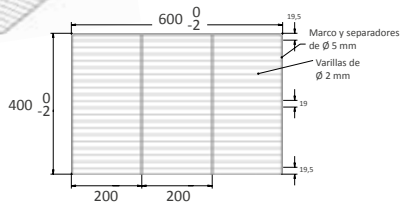

PP-GN 1/1

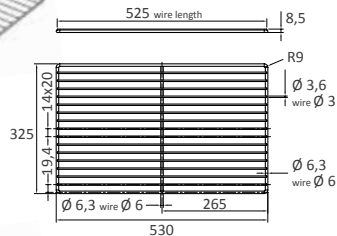

PP-GN 2/1

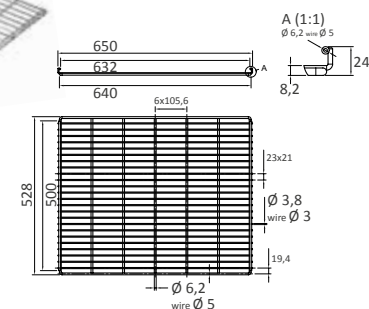

## PIG / PIP

Modelo Version	Código Code	Medidas Measures (mm.)	Capacidad máxima de carga Maximum loading capacity (kg.)	Peso Weight (kg.)
PIGN 1/1	FIO 7022	530x325	7	0,82
PIGN 2/1	FIO 7023	530x650	10	1,15
PIP6040	FIO 7024	400x600	8	1

# PP-GN

Estantes varilla en acero con recubrimiento plástico

Plastic coated steel tray

## PP-GN

Modelo Version	Código Code	Medidas Measures (mm.)	Capacidad máxima de carga Maximum loading capacity (kg.)	Peso Weight (kg.)
PP-GN 1/1	FIO 0051	530 x 325	7	0,934
PP-GN 2/1	FIO 0052	530 x 650	10	1,86

# BRA / BLA

Bandeja Aluminio

Aluminium tray

**BRA**

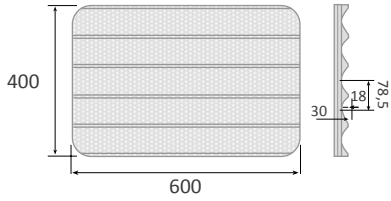

**BLA**

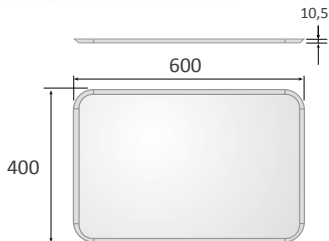

## BRA / BLA

Modelo Version	Código Code	Acabado Finish	Peso Weight (gr.)
<b>BRA</b>	F10 6924	Ranurada	850
<b>BLA</b>	F10 6926	Lisa	820

# BCR / BCS

## Bandejas para carros

- Material: Acero inox. AISI 304
- Chapa de 1 mm. de espesor
- Fabricadas por embutición en una sola pieza
- Fijación por tornillos o para soldar

## Trays for trolley

- Built in 1 mm. thickness AISI 304 stainless steel
- One part stretch-forming manufactured
- By screws or welding fixing

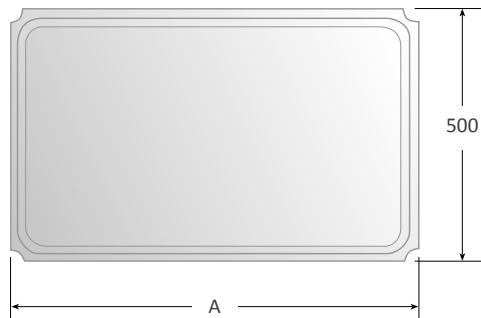

Para atornillar  
To be threaded



Para soldar  
To be welded

## BCR / BCS

Modelo Version	Código Code	A (mm.)	Peso Weight (kg.)
<b>Para atornillar / To be threaded</b>			
<b>BCR-85</b>	F10 9473	800	4,25
<b>BCR-105</b>	F10 9474	1000	4,7
<b>Para soldar / To be welded</b>			
<b>BCS-85</b>	F10 9463	800	4,16
<b>BCS-105</b>	F10 9464	1.000	4,90

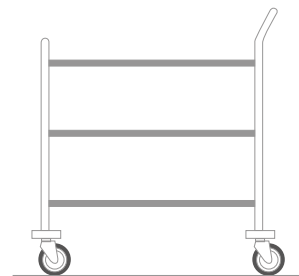

# TZ-34 / TZ-33

## Uniones Tubulares

- Unión tubular para tubo de 40 x 40, espesor 1 mm.

## Tubular joint

- Tubular joint for tubes of 40 x 40, 1 mm thickness

### TZ-34 / TZ-33

Modelo Version	Código Code	Peso Weight (gr.)
TZ-34	F10 0294	70
TZ-33	F10 0298	88

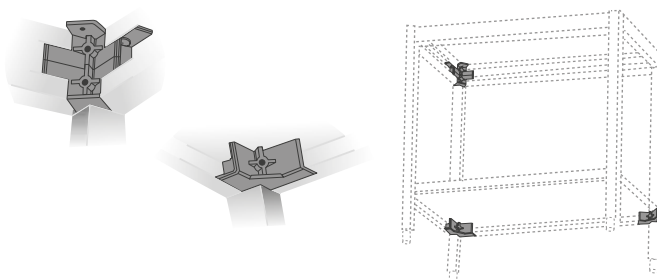

TZ-34

TZ-33

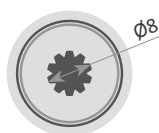
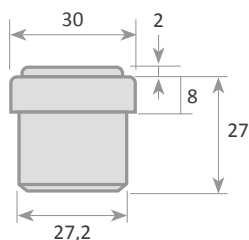
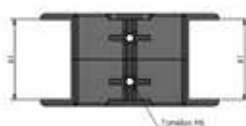
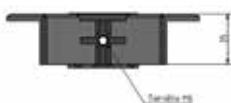
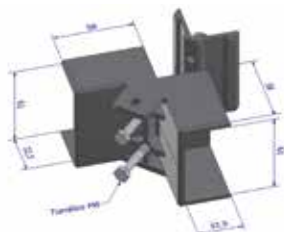

# TTR-30

## Cojinete para rodillo transportador

- Carcasa de polipropileno rodamiento de bolas de una hilera en acero inoxidable para tubo de Ø30x1,5 mm y eje de Ø8 mm

## Bushings for roller conveyor

- Polypropylene shell single row ball bearing in stainless steel for Ø30x1.5 mm tube and Ø8 mm shaft

### TTR-30

Modelo Version	Código Code	Peso Weight (gr.)
TTR-30	F10 3846	12

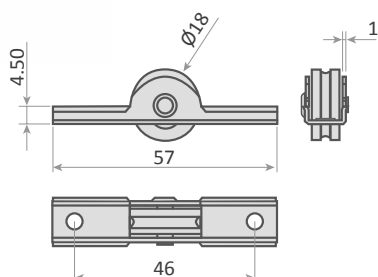

# CA-219-01

## Rodamiento

## Bearing

### CA-219-01

Modelo Version	Código Code	Peso Weight (gr.)
CA-219-01	F10 8058	23

PGP-G



PGP-N

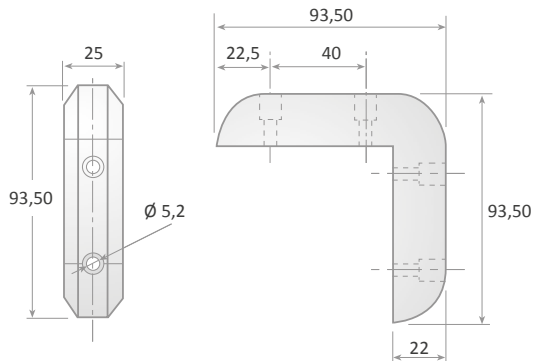

# PGP/PGR-2/PGC/PGT

Paragolpes

Bumper

## PGP / PGR-2 / PGC / PGT

Modelo Version	Código Code	Color Colour	Peso Weight (gr.)
<b>PGP-G</b>	FI0 1218	Gris Grey	90
<b>PGP-N</b>	FI0 1233	Negro Black	90
<b>PGR-2</b>	FI0 3761	Gris Grey	87
<b>PGC</b>	FI0 3762	Gris Grey	87
<b>PGT</b>	FI0 1236	Gris Grey	150

PGR-2

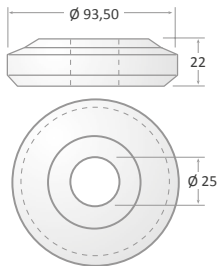

PGC

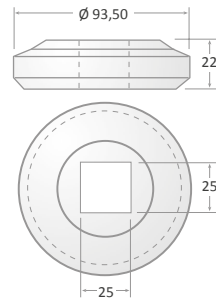

PGT

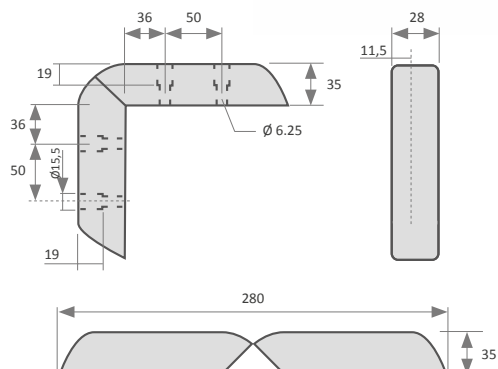

# TPD / DG / DS / MDG

Paragolpes y tapas desbroce

Bumper and scrap lid

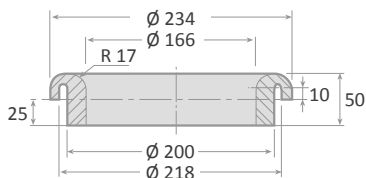
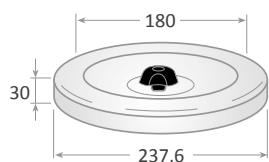

## TPD-1 / DG-1 / DS-1

Modelo Version	Código Code	Color Colour	Descripción Description	Peso Weight (gr.)
<b>TPD-1</b>	F10 5561	Acero inox. AISI 304 18/8 Stainless steel	Tapa Lid	400
<b>DG-1 Y</b>	F10 7347	Amarillo Yellow	EPDM	653
<b>DG-1 B</b>	F10 7349	Azul Blue	EPDM	653
<b>DG-1 G</b>	F10 7348	Verde Green	EPDM	653
<b>DG-1 R</b>	F10 7346	Rojo Red	EPDM	653
<b>DG-1 N</b>	F10 0573	Negro Black	EPDM	653
<b>DS-1</b>	F10 0617	Rojo Red	Silicona Silicone	630



Imán moldeado en PE sobre placa de acero inoxidable, dimensiones 120 x 35 mm. Los cubiertos de metal son recogidos por un potente imán.

Apto para materiales acero inoxidable ferrítico.

Magnet moulded in PE on stainless steel plate, dimensions 120 x 35 mm. Metal cutlery is picked up by a strong magnet. Suitable for ferritic stainless steel materials

## MDG

Modelo Version	Código Code	Descripción Description	Peso Weight (gr.)
<b>M1DG</b>	F10 8630	Imán simple para DG-1 Simple magnet for DG-1	-
<b>M2DG</b>	F10 8631	Imán doble para DG-1 Double magnet for DG-1	-

# TPD / DG / DS / TPDA

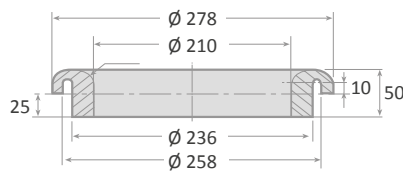
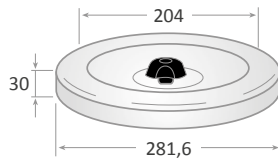

## TPD-2 / DG-2 / DS-2

Modelo Version	Código Code	Color Colour	Descripción Description	Peso Weight (gr.)
<b>TPD-2</b>	F10 9037	Acero inox. AISI 304 18/8 Stainless steel	Tapa Lid	524
<b>DG-2</b>	F10 9035	Negro Black	EPDM	942
<b>DS-2</b>	F10 9036	Rojo Red	Silicona Silicone	952

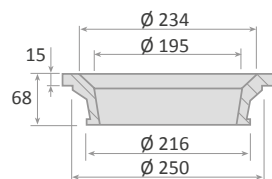
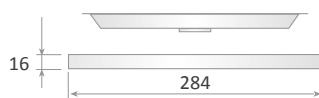

## TPDA-3 / DG-3

Modelo Version	Código Code	Color Colour	Descripción Description	Peso Weight (gr.)
<b>TPDA-3</b>	F10 9194	Acero inox. AISI 304 18/8 Stainless steel	Tapa y aro Lid and ring set	566
<b>DG-3</b>	F10 2626	Negro Black	Goma Rubber	1.110



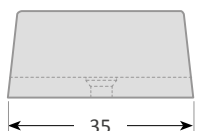
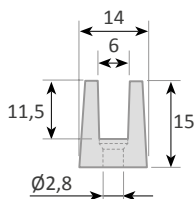

## FCA-1

### Prensa cristales

- Fijación cristal
- Fabricado en poliamida negra
- Para cristal de 6 mm - superficie plana

### Fixing for glass

- Glass clamp
- Made of black polyamide .
- For glass 6 mm. - For flat surfaces

### FCA-1

Modelo Version	Código Code	Peso Weight (gr.)
FCA-1	F10 0404	3

PC-01

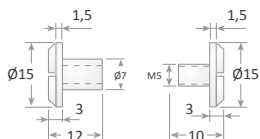

PC-02

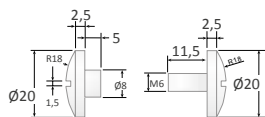

## PC

### Prensa cristales en latón cromado

### Chromed brass fixing for side glass

### PC

Modelo Version	Código Code	Peso Weight (gr.)
PC-01	F10 0823	10
PC-02	F10 3833	8

## PC-50

### Prensa cristales AISI 304

- Para vidrio: 6-16 mm
- Mate

### Glass clip AISI 304

- For glass: 6-16 mm
- Matte

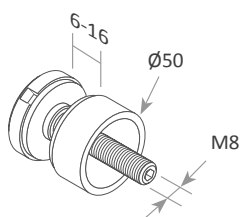

### PC-50

Modelo Version	Código Code	Diámetro Diameter (Ø mm)	Peso Weight (gr.)
PC-50	F10 8891	30	10

# PC-616-S

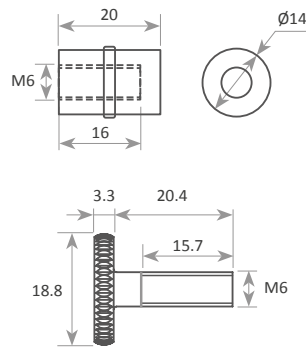

## Prensa cristales

- Para vidrio: 6-16 mm
- Tornillo acero inoxidable
- Cuerpo en aluminio

## Glass clip

- For glass: 6-16 mm
- Stainless steel screw
- Aluminium body

### PC-616-S

Modelo Version	Código Code	Diámetro Diameter (Ø mm)	Peso Weight (gr.)
PC-616-S	FIO 3842	18,8	20

# SEC-01

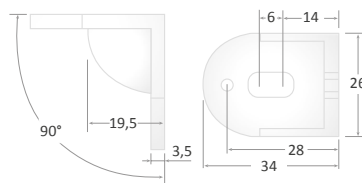

## Escuadra soporte para cristal en metacrilato transparente

## Square support for glass manufactured in clear methacrylate

### SEC-01

Modelo Version	Código Code	Peso Weight (gr.)
SEC-01	FIO 3403	6

# PC

## Prensa cristales de acero inoxidable

## Stainless steel glass fixing

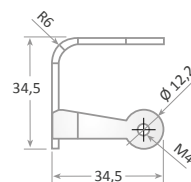

PC-03

### PC

Modelo Version	Código Code	Peso Weight (gr.)
PC-03	FIO 4098	18
PC-04	FIO 4099	30

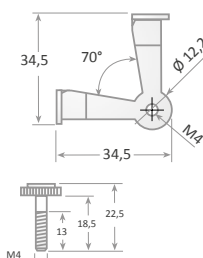

PC-04

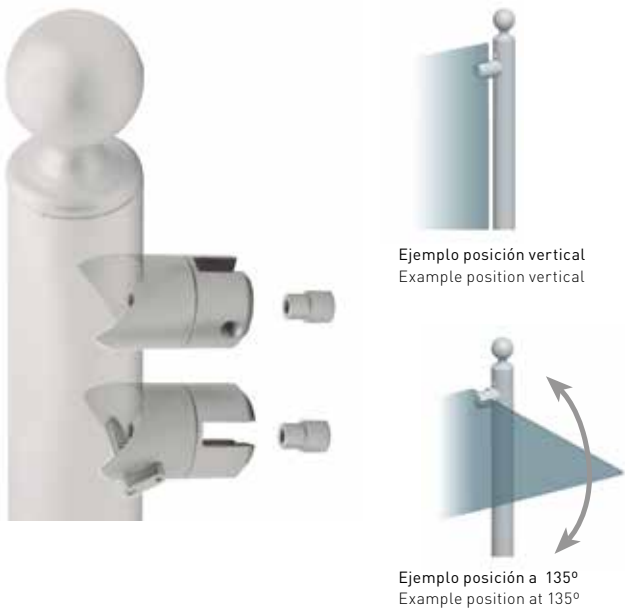

# FBR-P

**Conjunto prensa cristales**

- Soporte móvil para cristal, con seguro a 135°

**Fixing for glass set**

- Swivel glass clip with retainer (135°), silver colour

**FBR-P**

Modelo Version	Código Code		Peso Weight (gr.)
FBR/P	F10 1992		210

# FV / FH

**Prensa cristales**

**Fixing for glass**



**FV / FH**

Modelo Version	Código Code	Color Colour	Peso Weight (gr.)
<b>Redondo / Rounded</b>			
FH-P	F10 1062	Plata Silver	30
FV-P	F10 1207	Plata Silver	32

**Cuadrado / Square**

FH-P	F10 6435	Plata Silver	7
FV-P	F10 6431	Plata Silver	7

Prensa cristal / Glass clip

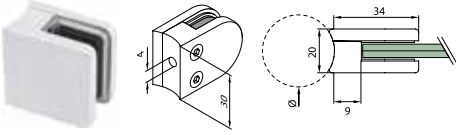
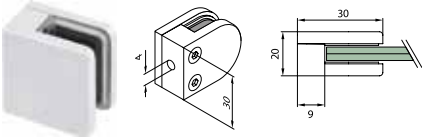
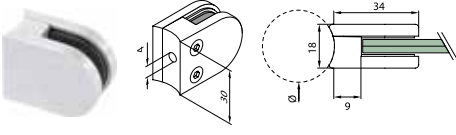
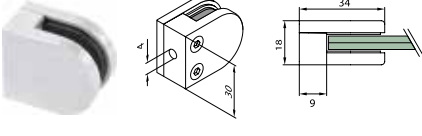
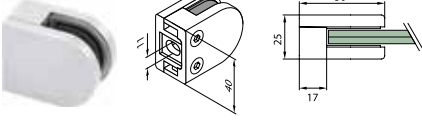
	Modelo Version	Código Code	Medidas Measures (mm.)	Para vidrio For glass (mm.)	Materiel Material	Para tubo For tube	Caja Box (Un.)
	<b>CCP-C</b>	FIO 2644	34x30x20	6 - 8,76	Satinado Inoxidable AISI-304 Satin Stainless steel AISI-304	Redondo Round Ø 30	10
	<b>CCP-CP</b>	FIO 2652	30x30x20	6 - 8,76	Satinado Inoxidable AISI-304 Satin Stainless steel AISI-304	Plano Flat	10
	<b>CCPI</b>	FIO 6921	34x30x18	6	Satinado Inoxidable AISI-304 Satin Stainless steel AISI-304	Redondo Round Ø 30	10
	<b>CCPI-P</b>	FIO 2643	34x30x18	6	Satinado Inoxidable AISI-304 Satin Stainless steel AISI-304	Plano Flat	10
	<b>5001-E-M</b>	FIO 4496	50x40x25	8- 10	Satinado Inoxidable AISI-316 Satin Stainless steel AISI-316	Plano Flat	-
	<b>5003-E-M</b>	FIO 4497	50x40x25	8- 10	Satinado Inoxidable AISI-316 Satin Stainless steel AISI-316	Redondo Round Ø 43 - 50,8	-

Juego de gomas para mod. tubix 5001 y 5003 / Rubber set for mod. tubix 5001 y 5003



**3281**

FIO 3281

-

6

-

-

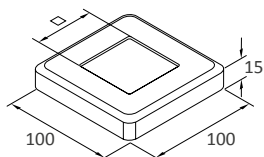

**Valonas para placa de fijación**

**Flanges for fixing plate**

Modelo Version	Código Code	Para tubo For tube	H (mm.)	Un. Un.
<b>VAL-C-3</b>	F10 7338	40 x 40	15	40
<b>VAL-C-4</b>	F10 7339	50 x 50	15	40

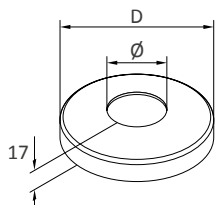

**Valona redonda - Acabado Plano**

- Acero inoxidable AISI 316
- Interior - Exterior
- Pulido brillo

**Round flange - Flat Finish**

- Stainless steel AISI 316
- Inside - Outside
- Bright polished

Modelo Version	Código Code	Diámetro Diameter	D (mm.)	H (mm.)	Un. Un.
<b>VAL-65-12-A</b>	F10 7923	25	65	17	20
<b>VAL-65-14-A</b>	F10 7925	30	65	17	20
<b>VAL-100-1</b>	F10 7340	38	100,5	17	20

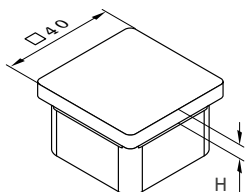

**Tapa final fundición**

- para tubo cuadrado de 40 x 40 x 1,5

**Foundry end cap**

- for square tube 40 x 40 x 1,5

Modelo Version	Código Code	Para tubo For tube	H (mm.)	Un. Un.
-	F10 8649	40 x 40 x 1,5	5	15

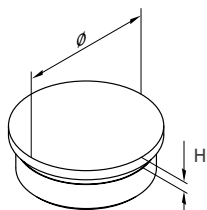

**Tapa final fundición**

**Foundry end cap**

Modelo Version	Código Code	Diámetro Diameter	H (mm.)	Un. Un.
-	F10 9240	38	3	6