

**PERFILES SANITARIOS**  
SANITARY PROFILES

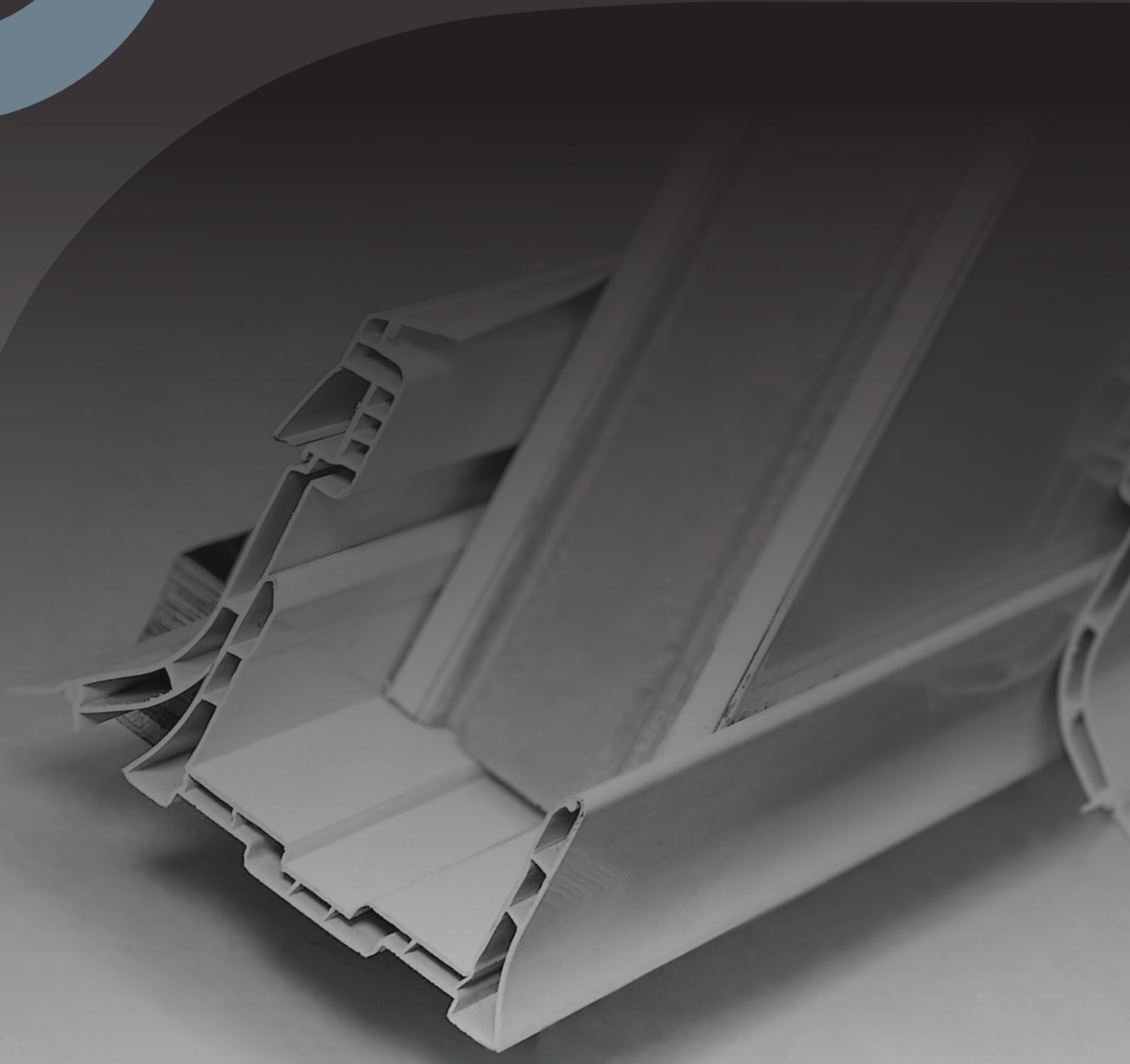

## 290 P

### Perfil sanitario con labios flexibles

Sanitary profiles with soft edges

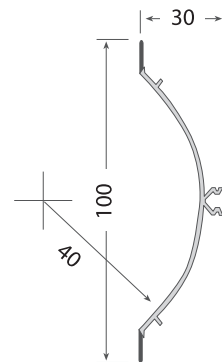

## 3300 A

### Perfil sanitario

Sanitary profiles

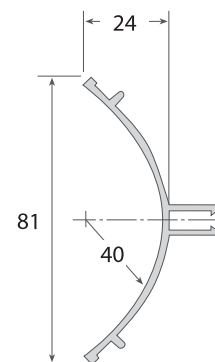

## 295

### Unión angular interior triple

Internal corner cap

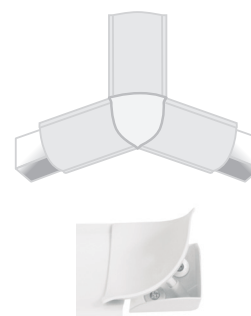

Modelo Version	Código Code	Largo Length (mts)	Color Colour (Ral)	Material Material	Pedido mínimo Minimum order (mts)	Peso Weight (gr/mt)
<b>290 P</b>	F10 2805	4	9002	PVC	120	765
	F10 3318	4	9010	PVC	120	765
<b>3300 A</b>	F10 7271	4	9010	Aluminio Aluminium	50	2.200
<b>295</b>	F10 2815	-	9002	PVC	1	21 (gr/un)
	F10 3319	-	9010	PVC	1	21 (gr/un)

# 3305 A

## Unión angular interior triple

Internal corner cap

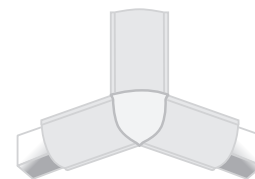

# 289

## Unión angular exterior

Large external corner cap

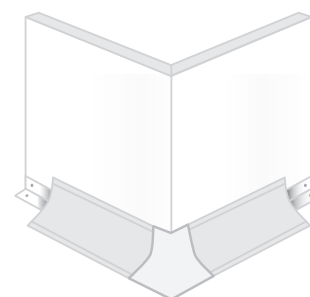

# 288

## Tapa final grande

Large end cap

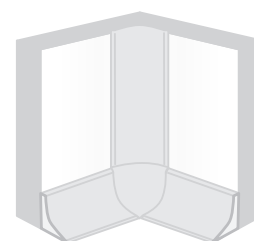

Modelo Version	Código Code	Largo Length (mts)	Color Colour (Ral)	Material Material	Pedido mínimo Minimum order	Peso Weight (gr/un)
<b>3305 A</b>	F10 7273	-	9010	Aluminio Aluminium	1	54
<b>289</b>	F10 3984	-	9002	PVC	1	16
	F10 3985	-	9010	PVC	1	16
<b>288</b>	F10 3986	-	9002	PVC	1	7
	F10 3987	-	9010	PVC	1	7

Ángulo de fijación para perfil 290-P / 3300 A

L-backing profile for 290-P / 3300 A

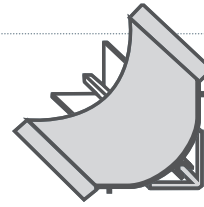

**316 P**

PVC

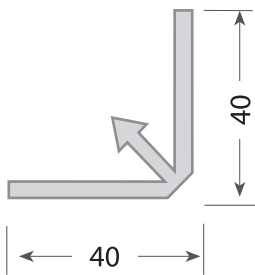

**291 A-3**

Aluminio  
Aluminium

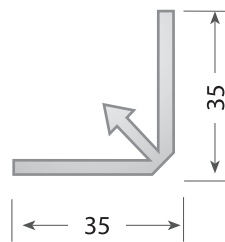

**315 P**

PVC

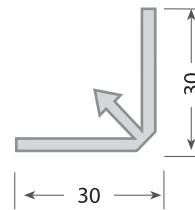

**299 A-25**

Aluminio  
Aluminium

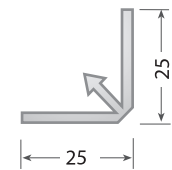

PVC



Aluminio  
Aluminium

Modelo Version	Código Code	Largo Length (mts)	Color Colour (Ral)	Material Material	Pedido mínimo Minimum order (mts)	Peso Weight (gr/mt)
<b>316 P</b>	F10 5559	4	9002	PVC	120	1.800
<b>291 A-3</b>	F10 2806	4	-	Aluminio Aluminium	120	317
<b>315 P</b>	F10 1364	4	9002	PVC	120	220
<b>299 A-25</b>	F10 8393	4	-	Aluminio Aluminium	120	195

## 3097 A+B

Perfil sanitario con labios flexibles

Sanitary profiles with soft edges

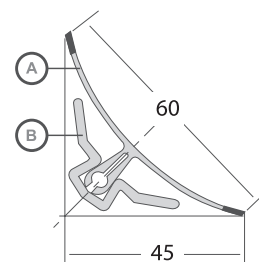

## 2738 A+B

Perfil sanitario con labios flexibles

Sanitary profiles with soft edges

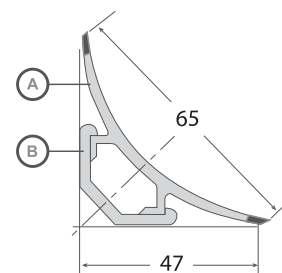

## 246 A+B

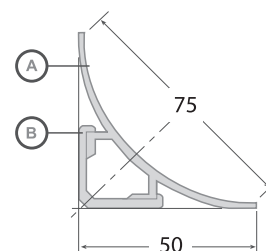
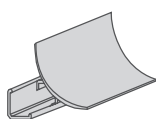

## 1020

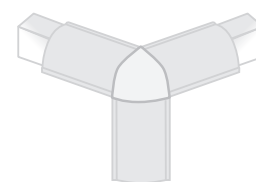

Modelo Version	Código Code	Largo Length (mts)	Color Colour (Ral)	Material Material	Pedido mínimo Minimum order (mts)	Peso Weight (gr/mt)
<b>3097 A+B</b>	F10 4472	4	9002	PVC	80	1.230
	F10 3811	4	9010	PVC	80	1.230
<b>2738 A+B</b>	F10 4471	4	9002	PVC	100	1.130
	F10 3327	4	9010	PVC	100	1.130
<b>246 A+B</b>	F10 1935	4	-	PVC	100	1.300
<b>1020</b>	F10 5715	Unidad	-	PVC	-	110 (gr/un)

# 312

**Perfil sanitario**

Sanitary profiles

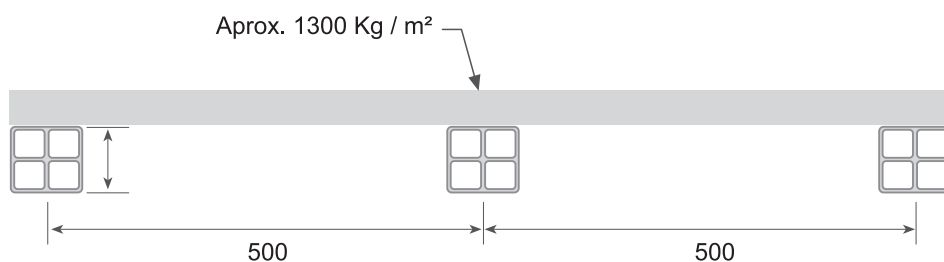
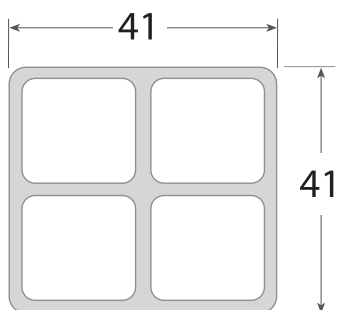
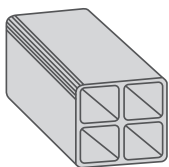

Modelo Version	Código Code	Largo Length (mts)	Color Colour (Ral)	Material Material	Pedido mínimo Minimum order (mts)	Peso Weight (kg)
312	F10 1149	4	Blanco Negro Gris White Black Grey	PVC	30	2,1

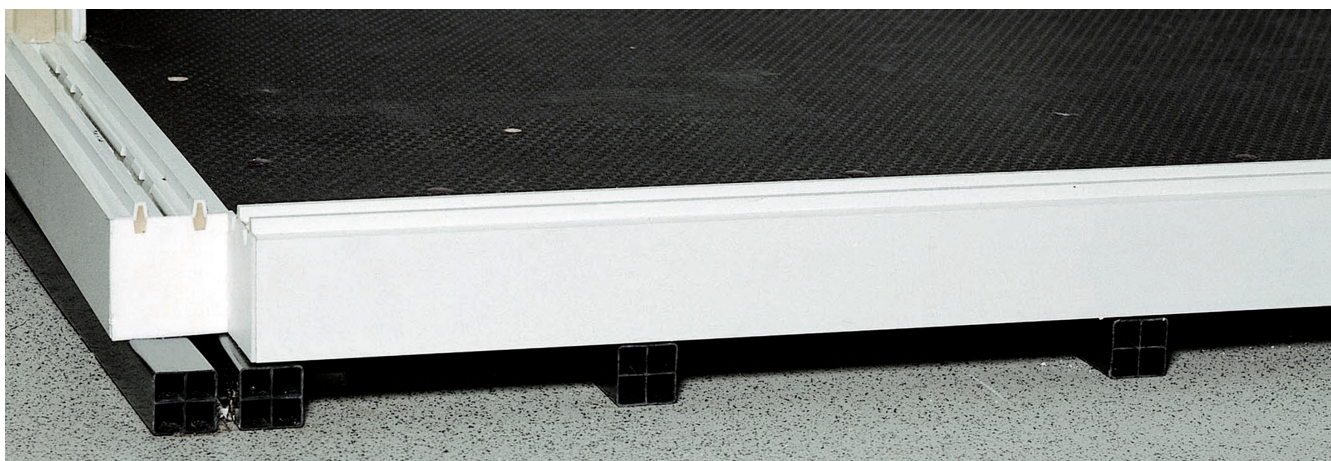

# 293

## Zócalo con labios flexibles y fijación oculta

Plinth with soft edges on both sides and invisible fixing

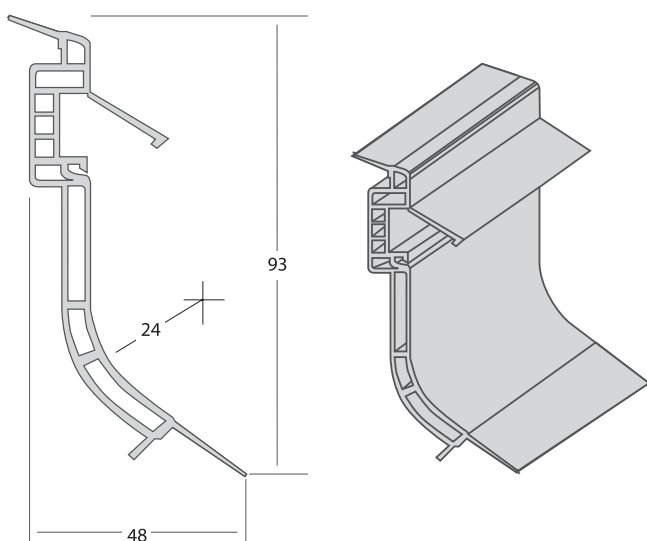

Modelo Version	Código Code	Largo Length (mts)	Color Colour (Ral)	Material Material	Pedido mínimo Minimum order (mts)	Peso Weight (kg)
<b>293</b>	F10 2810	4	9002	PVC	80	1,7
	F10 3328	4	9010	PVC	80	1,7



## 296 I

Unión angular interior para zócalo

Internal corner cap for plinth

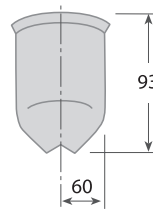
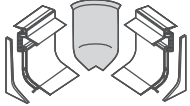

## 304 E

Unión angular exterior para zócalo

External corner cap for plinth

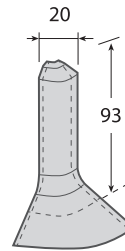
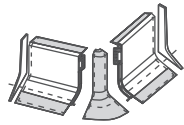

## 297

Tapa lateral para perfil zócalo

End cap for plinth profile

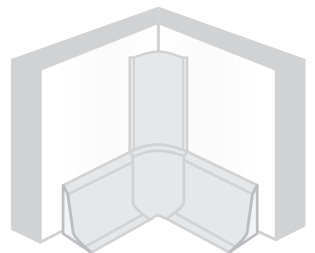
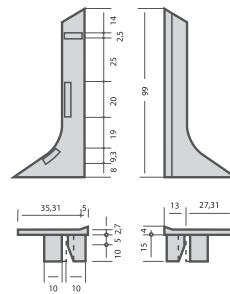
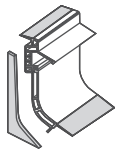

## 303 T

Tapa superior para zócalo

Upper piece accessory

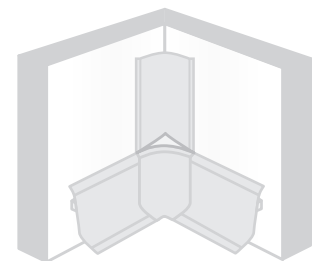
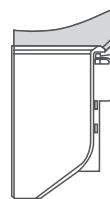

Modelo Version	Código Code	Unidad Unit	Color Colour (Ral)	Material Material	Caja Box (mts)	Peso Weight (gr/un)
296 I	F10 2816	1	9002	PVC	-	32
	F10 2934	1	9010	PVC	-	32
304 E	F10 2820	1	9002	PVC	-	27
	F10 2935	1	9010	PVC	-	27
297	F10 2817	1	9002	PVC	-	7
	F10 3815	1	9010	PVC	-	7
303 T	F10 2819	1	9002	PVC	-	7



# TH-ALU-01

**Perfil T-omega en aluminio con fijación atérmica con rotura del puente térmico**

T-omega ceiling suspension profile made from aluminium with thermal break

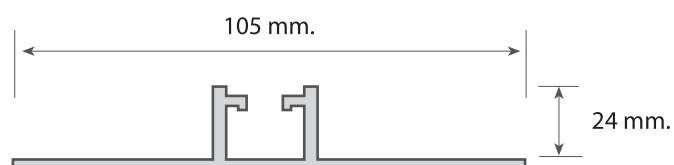
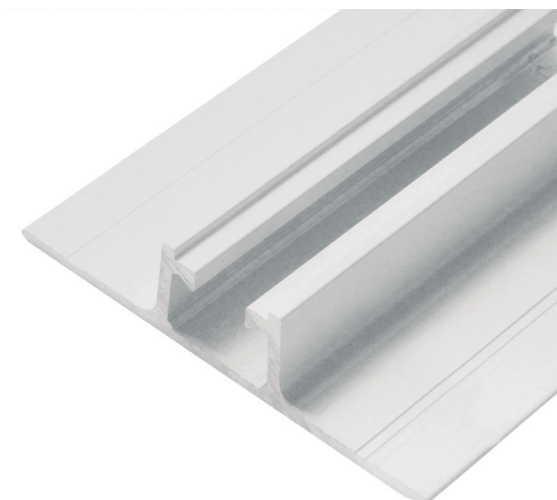

# A-326

**Conexión atérmica**

Connector



Modelo Version	Código Code	Largo Length (mts)	Color Colour (Ral)	Material Material	Caja Box (mts)	Peso Weight (gr)
TH-ALU-01	F10 3819	4	9002	Aluminio Aluminium	8	5.460
A-326	F10 3835	10	Verde Green	Aluminio sobreinyectado Overinjected aluminium	Unidad Unit	60

# A88-M10 / 321 CH

Perfiles suspensión panel al techo y fijación.  
Pieza de fijación en acero zincado para perfil T en rosca M-10.

Ceiling suspension profiles and fixations.  
Zinc-plated fixing part with thread M-10 for hanging T profile.

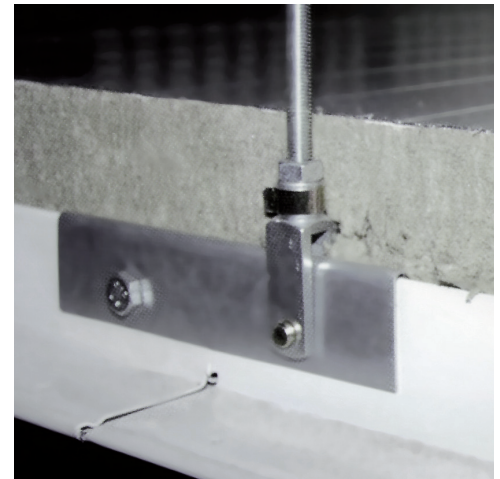
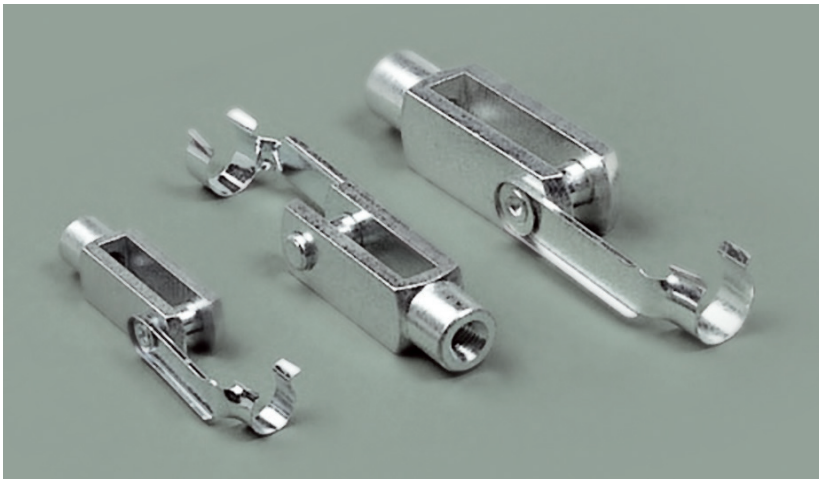
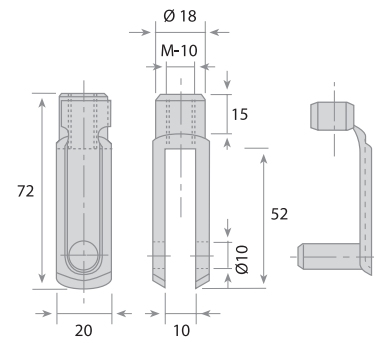

# 320 - TA

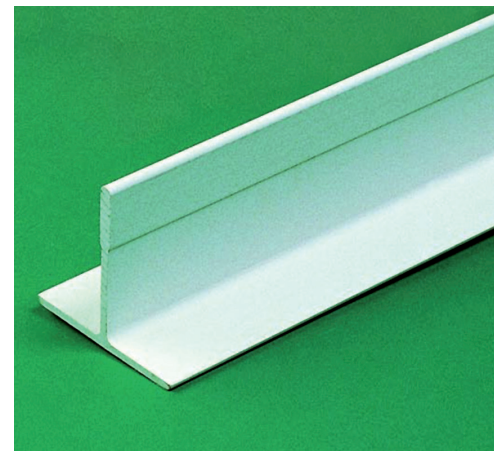
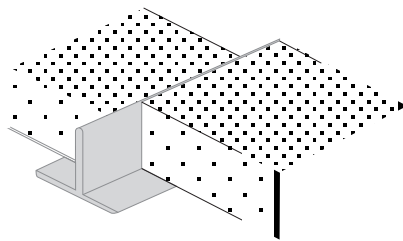
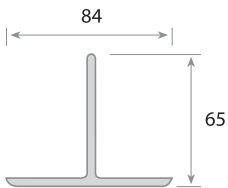

Modelo Version	Código Code	Largo Length (mts)	Color Colour (Ral)	Material Material	Caja Box (mts)	Peso Weight (gr/mt)
<b>A88-M10</b>	F10 5711	Unidad Unit	Acero Steel	Acero zincado Zinc-plated	-	1.200 (gr/un)
<b>320 TA</b>	F10 5710	4	9010	Aluminio Aluminium	-	1.625

# 294

Perfiles en U con bordes redondeados, fabricados en PVC rígido para fijación de paneles frigoríficos al suelo

Rounded U channel profiles

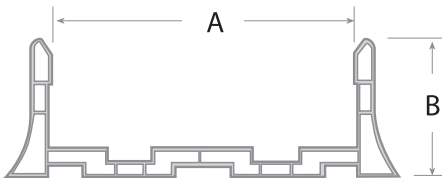
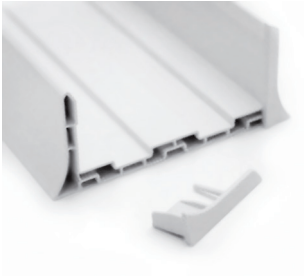

# 298

Tapa lateral para perfil en U

Upper piece accessory

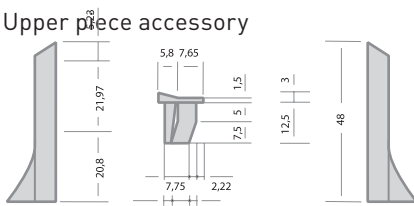

Modelo Version	Código Code	Largo Length (mts)	Color Colour (Ral)	Material Material	A ↔ (mm)	B ↓ (mm)	Peso Weight (gr/mt)
294-6	F10 2811	3	9002	PVC	60	45	500
294-8	F10 2812	3	9002	PVC	80	45	600
294-10	F10 2813	3	9002	PVC	100	45	600
294-12	F10 2814	3	9002	PVC	120	45	700
					<b>Unidad Unit</b>		
298	F10 2818	-	9002	PVC		1	2 (gr/un)

## BL-312

Tornillo

Screws

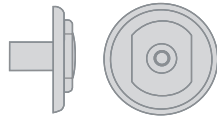

## BLP-316

Bulón pasante

Pitch screws

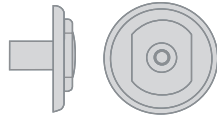

## BLI-350

Bulón con inserto metálico

Screw with metallic insert

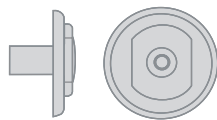

## A-314

Arandela

Washer

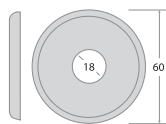

Modelo Version	Código Code	Unidad Unit	Color Colour (Ral)	Material Material	Caja Box (mts)	Peso Weight (gr/un)
BL-312-8	FIO 2846	1	9002	POM	-	10
BL-312-10	FIO 2876	1	9002	POM	-	11
BL-312-12	FIO 1060	1	9002	POM	-	13
BLP-316-10	FIO 5600	1	9002	POM	-	11
BL-350-10	FIO 9888	1	9002	POM	-	26
A-314	FIO 2877	1	-	-	-	6

## SCH-8 (M-12)

Bulón embellecedor en PVC con inserto metálico

PVC cover screw with metallic insert

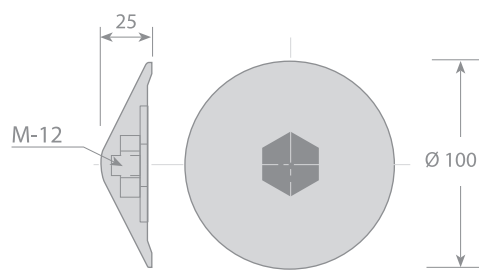

## SCH-9 (M-10)

Bulón embellecedor en PVC con inserto metálico

PVC cover screw with metallic insert

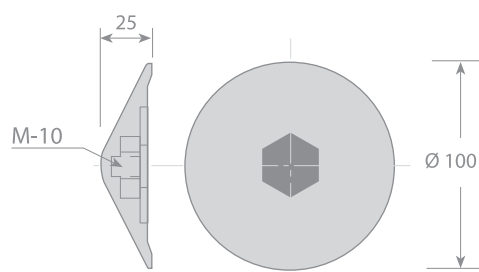

Modelo Version	Código Code	Unidad Unit	Color Colour (Ral)	Material Material	Caja Box (mts)	Peso Weight (gr/un)
SCH-8	F10 6003	1	9010	PVC	-	110
SCH-9	F10 3790	1	9010	PVC	-	85

**Separadores de panel. Conjunto de 3 pies fabricado en P.A. negro.  
Soportan hojas de acero.**

Panel separator. 3 feet set panel separator made of P.A.  
Support the steel sheets.

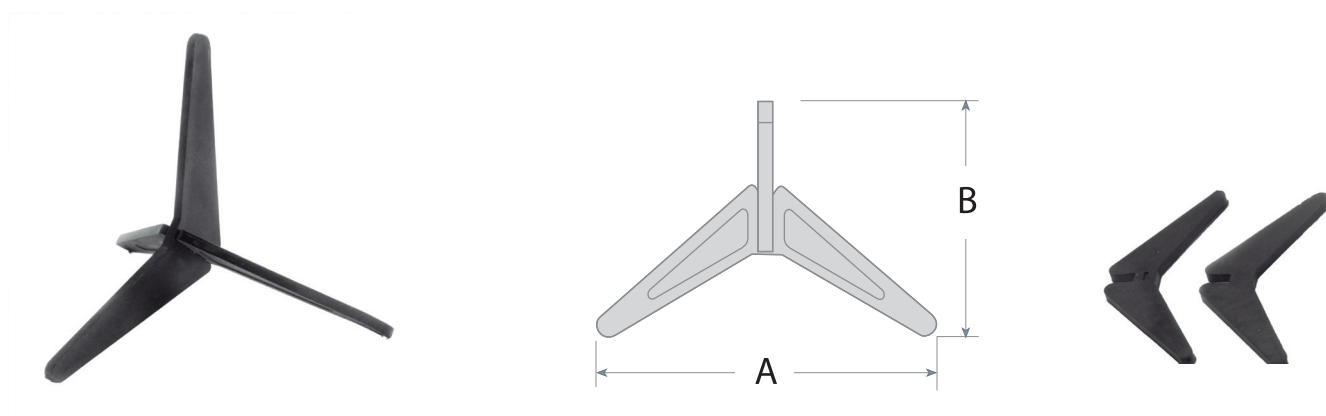

Modelo Version	Código Code	A ↔ (mm)	B ↓ (mm)	Peso Weight (gr)
<b>D-50</b>	F10 7253	65	50	4
<b>D-60</b>	F10 7254	75	60	5
<b>D-75</b>	F10 7255	90	75	6
<b>D-80</b>	F10 7256	95	80	7
<b>D-100</b>	F10 7257	120	100	9
<b>D-120</b>	F10 7258	145	120	18
<b>D-140</b>	F10 7259	170	140	25
<b>D-150</b>	F10 7260	180	150	26
<b>D-160</b>	F10 7261	195	160	36
<b>D-180</b>	F10 7262	220	180	42